

HELCOM Manual on Co-operation in Response to Marine Pollution

within the framework of the Helsinki Convention



HELSINKI COMMISSION
Baltic Marine Environment Protection Commission

Katajanokanlaituri 6 B
FI - 00160 Helsinki
Finland

+358 207 412 649
www.helcom.fi

Table of Contents

INTRODUCTION	6
PURPOSE OF THE MANUAL	6
DESCRIPTION OF THE CONTENTS	7
UPDATING OF THE MANUAL	7
1. INFORMATION BY THE CONTRACTING PARTIES	8
1.1. DENMARK (DK)	8
1.2. ESTONIA (EE).....	9
1.3. EUROPEAN UNION (EU).....	9
1.4. FINLAND (FI)	10
1.5. GERMANY (DE)	10
1.6. LATVIA (LV)	11
1.7. LITHUANIA (LT)	12
1.8. POLAND (PL)	12
1.9. RUSSIA (RU)	13
1.10. SWEDEN (SE).....	14
2. GUIDELINES FOR OPERATIONAL CO-OPERATION	15
2.1. COMMAND STRUCTURE	15
2.2. OPERATIONAL COMMUNICATION.....	18
2.3. OTHER PRINCIPLES FOR OPERATIONAL CO-OPERATION.....	19
3. REQUESTING AND PROVIDING ASSISTANCE	22
3.1. OBLIGATIONS OF THE REQUESTING PARTY.....	22
3.2. OBLIGATIONS OF THE ASSISTING PARTY.....	24
3.3. REQUESTING FOR A PLACE OF REFUGE FROM A NEIGHBOURING CONTRACTING PARTY	24
4. ADMINISTRATIVE AND ORGANIZATIONAL SUPPORT OF THE REQUESTING PARTY	27
4.1. GENERAL PRINCIPLES.....	27
4.2. ISSUES TO BE CONSIDERED IN JOINT OPERATIONS AT SEA.....	29
4.3. ISSUES TO BE CONSIDERED IN JOINT OPERATIONS ON THE SHORE	30
5. POLLUTION REPORT	32
5.1. PARTS OF THE REPORTING SYSTEM	32
5.2. IDENTIFICATION OF THE REPORTS	33
5.3. DETAILED INFORMATION OF THE REPORTING SYSTEM	34
6. CO-OPERATION IN AERIAL SURVEILLANCE	41
6.1. FLIGHT TYPES.....	42

6.1.1.	Regular National Flights.....	42
6.1.2.	CEPCO Flights.....	42
6.2.	GUIDELINES FOR NATIONAL AERIAL SURVEILLANCE.....	43
6.3.	REPORTING	45
7.	CO-OPERATION IN OILED WILDLIFE RESPONSE.....	46
7.1.	GENERAL PRINCIPLES.....	46
7.2.	POLLUTER PAYS	47
7.3	WILDLIFE SCENARIOS AND COOPERATION	47
7.4	INTERNATIONAL OBJECTIVES OF A WILDLIFE RESPONSE.....	47
7.5	APPLICABLE TOOLS AND PRINCIPLES.....	48
7.6	NATIONAL PREPAREDNESS.....	50
7.7	PREPAREDNESS BETWEEN CONTRACTING PARTIES.....	51
7.8	STRIKE TEAMS FOR WILDLIFE RESPONSE	51
7.9	ASSISTANCE FROM THE EUROWA NETWORK	52
7.10	TRAINING AND EXERCISES.....	52
7.11	REFERENCES.....	53
8.	FRAMEWORK FOR EXERCISES	54
9.	FINANCIAL ASPECTS	56
9.1.	PRINCIPLES OF COSTS OF ASSISTANCE	56
9.2.	CALCULATION OF COSTS OF ASSISTANCE	56
9.2.1.	Costs of a Ship	57
9.2.2.	Other Costs.....	58
10.	OIL SAMPLING	60
10.1.	OIL SAMPLING	60
10.2.	KEY ASPECTS OF OIL SAMPLING	60
Annex 1.....	Terms Used in the Manual	62
Annex 2.....	National Response Structure of the Contracting Parties and the Role of the EU in Marine Pollution Response	67
Annex 3.....	Bi- and Trilateral Agreements	76
Annex 4.....	EU Host Nation Support.....	85
Annex 5.....	POLREP Reporting Template	92
Annex 6.....	POLREP Sample Messages	95
Annex 7.....	Nomenclature for Describing the Oiling of the Shore.....	100

Annex 8.....	103
List of Waypoints Used in Aerial Surveillance	103
Annex 9.....	109
HELCOM Response Grid.....	109
Annex 10.....	111
Terms of Reference of the HELCOM Exercise Development and MOnitoring Team (HEDMOT)	111
Annex 11.....	113
The HREP process.....	113
Annex 12.....	115
Guidelines for Oil Sampling.....	115

INTRODUCTION

The Baltic Sea co-operation in responding to spillages of oil and other harmful substances is based on the articles 13 and 14 of [the Helsinki Convention](#)¹ and HELCOM Recommendations, adopted by the Helsinki Commission. Since 2014 the Convention has explicitly also covered response co-operation on the shore.

[Annex VII: Response to Pollution Incidents](#) of the Convention gives a legal status to the HELCOM Manual on Co-operation in Response to Marine Pollution (in the following the Manual). The Manual is applied by the Baltic Sea countries in operational co-operation, surveillance activities and response exercises. In Annex VII the provisions of response to pollution incidents are defined and the Contracting Parties agree to apply, as far as practicable, the principles and rules included in the Manual.

This Manual combines the previous Volume 1 regarding oil response to pollution incidents mostly at sea and Volume 3 which concentrates on response on the shore. Volume 2, replaced by the Joint Inter-Regional Marine HNS Response Manual, describes response to accidents at sea involving spills of hazardous substances.

This Manual should be regarded as a practical implementation of the International Convention on Oil Pollution Preparedness, Response and Co-operation (OPRC Convention).

PURPOSE OF THE MANUAL

According to the Helsinki Convention the Contracting Parties shall agree bi- or multilaterally on those regions of the Baltic Sea, in which they act together. This is to maintain ability to respond to spillages of oil and other harmful substances as effectively as possible. The Manual should be used as guidance and help for bi- and multilateral co-operation and participation in joint actions.

This Manual is intended for Response Commanders and Supreme On-Scene Commanders leading the multinational response operations at sea and on the shore. It is also meant for personnel participating in the multinational response operations and for authorities dealing with national contingency planning and strategic development.

¹ Convention on the Protection of the Marine Environment of the Baltic Sea Area, 1992

DESCRIPTION OF THE CONTENTS

The Manual includes details on operational co-operation, as well as general arrangements in a joint operation.

Chapter 1 contains the National Contact Points of the Contracting Parties. Chapters 2, 3 and 4 describe the guidelines for co-operation, procedures for requesting and providing assistance and the administrative support a requesting Party should be able to give. The pollution reporting system is presented in Chapter 5.

Chapters 6 and 7 provide useful information on aerial surveillance and oiled wildlife response. The different types of response exercises and exercise planning, evaluation and reporting are explained in Chapter 8. Chapter 9 gives details on financial aspects that shall be paid attention to in joint response operations and Chapter 10 describes how the oil sampling process should be handled in order to obtain information about the spill.

The Manual contains 12 annexes that provide additional information for the chapters.

UPDATING OF THE MANUAL

The updating of the Manual is the responsibility of the Secretariat of the Helsinki Commission. The Manual is updated in accordance with information received from the Contracting Parties, instructions given by the HELCOM Response Working Group (as far as they do not concern fundamental revision) or decisions of the Helsinki Commission. The Contracting Parties report changes in the organization of their response authorities and/or improvement of their national response abilities.

The Contracting Parties shall submit their amendments to the meetings of the Response Working Group. The amendments will be updated by the Secretariat within two months. However, a Contracting Party is requested to immediately inform other Contracting Parties and the Secretariat, if substantial changes in their national organization and Contact Points in Chapter 1 are made. Substantial changes have an influence on providing and requesting assistance and exchanging information.

[The Manual](#), [all the valid recommendations](#) and [the HELSINKI Convention](#) are available on the HELCOM website.

1. INFORMATION BY THE CONTRACTING PARTIES

Each Contracting Party shall have a national system for responding promptly and effectively to oil pollution incidents. This system shall include as a minimum the designation of:

- Competent National Authority/Authorities with responsibility for marine pollution preparedness and response
- operational National Contact Point/Points² which are responsible for the receipt and transmission of oil pollution reports
- authority which is entitled to act on behalf of the country to requested assistance or to decide to render the assistance requested³.

The contact details of the nationally responsible operational bodies are listed below. The national response structure/system of each Contracting Party and the role of the EU in marine pollution response are explained in [Annex 2](#). A list of response equipment of the Contracting Parties can be found on the [HELCOM website](#).

1.1. DENMARK (DK)

National Contact Points for spills at sea, on the shore and oiled wildlife response

Operational Contact Point / Emergencies (24/7)	
Maritime Assistance Service Defence Command Denmark	Phone: +45 72 85 03 71 E-mail: mas@sok.dk Fax: + 45 72 85 03 84

Aerial surveillance – responsible authority

Operational Contact Point / Emergencies (24/7)	
Maritime Assistance Service Defence Command Denmark	Phone: +45 72 85 03 71 E-mail: mas@sok.dk Fax: +45 72 85 03 84

Contact points for joint aerial surveillance in the Baltic

Operational Contact Point / Emergencies (24/7)	
Maritime Assistance Service Defence Command Denmark	Phone: +45 72 85 03 71 E-mail: mas@sok.dk Fax: +45 72 85 03 84

² See [Annex 1](#) for terms used in the manual.

³ OPRC Convention, Article 6: National and Regional Systems for Preparedness and Response

Contact points for places of refuge

Operational Contact Point / Emergencies (24/7)	
Maritime Assistance Service Defence Command Denmark	Phone: +45 72 85 03 71 E-mail: mas@sok.dk Fax: +45 72 85 03 84

1.2. ESTONIA (EE)

National Contact Points for spills at sea, on the shore and oiled wildlife response

Operational Contact Point / Emergencies (24/7)	
Joint Rescue Coordination Centre (JRCC TALLINN)	Phone: +372 619 1224 E-mail: jrcc@politsei.ee Fax: +372 692 2501

Aerial surveillance – responsible authority

Operational Contact Point on weekdays	
Police and Border Guard Board Intelligence Management and Investigation Department Aviation Group	Phone: +372 614 9247 E-mail: lennusalk@politsei.ee Fax: +372 614 9264

Contact points for joint aerial surveillance in the Baltic

Operational Contact Point / Emergencies (24/7)	
Joint Rescue Coordination Centre (JRCC TALLINN)	Phone: +372 619 1224 E-mail: jrcc@politsei.ee Fax: +372 692 2501

Contact points for places of refuge

Operational Contact Point / Emergencies (24/7)	
Joint Rescue Coordination Centre (JRCC TALLINN)	Phone: +372 619 1224 E-mail: jrcc@politsei.ee Fax: +372 692 2501

1.3. EUROPEAN UNION (EU)

Contact Point / Emergencies (24/7)	
European Commission Directorate General for European Civil Protection and Humanitarian Aid Operations (DG ECHO) Emergency Response Coordination Centre (ERCC) Belgium	Phone: +32 2 29 21 112 E-mail: ECHO-ERCC@ec.europa.eu Fax: +32 2 29 86651
European Maritime Safety Agency (EMSA) Portugal	Phone: +351 21 1209 415 E-mail: MaritimeSupportServices@emsa.europa.eu Fax: +351 21 1209 480

EU can support the HELCOM Contracting Parties in preparedness and response to marine pollution mainly through the Union Civil Protection Mechanism and the European Maritime Safety Agency (EMSA), as described in [Annex 2. National Response Structure of the Contracting Parties and the Role of the EU in Marine Pollution Response](#). Information regarding places of refuge is published on [EMSA's website](#).

1.4. FINLAND (FI)

National Contact Points for spills at sea, on the shore and oiled wildlife response

Operational Contact Point / Emergencies (24/7)	
Maritime Rescue Coordination Centre (MRCC Turku)	Phone: +358 294 1001 E-mail: mrcc@raja.fi Fax: +358 294 1019

Aerial surveillance – responsible authority

Operational Contact Point / Office hours	
The Finnish Border Guard	Phone: +358 295 420 000 E-mail: rvle.me@raja.fi Fax: +358 295 411 500

Contact points for joint aerial surveillance in the Baltic

Operational Contact Point / Emergencies (24/7)	
Maritime Rescue Coordination Centre (MRCC Turku)	Phone: +358 294 1001 E-mail: mrcc@raja.fi Fax: +358 294 1019

Contact points for places of refuge

Operational Contact Point / Emergencies (24/7)	
Gulf of Finland area Gulf of Finland Coast Guard District MRSC Helsinki	Phone: +358 294 1002 E-mail: mrsc.helsinki@raja.fi Fax: +358 294 1099
Sea areas west from Hanko West Finland Coast Guard District MRCC Turku	Phone: +358 294 1001 E-mail: mrcc@raja.fi Fax: +358 294 1019

1.5. GERMANY (DE)

National Contact Points for spills at sea, on the shore and oiled wildlife response

Operational Contact Point / Emergencies (24/7)	
Central Command for Maritime Emergencies (CCME)	Phone: +49 30 185 420 1400 E-mail: mlz@havariekommando.de Fax: +49 30 185 420 2009

Aerial surveillance – responsible authority

Operational Contact Point / office hours	
Central Command for Maritime Emergencies (CCME)	Phone: +49 30 185 420 1400 E-mail: mlz@havariekommando.de Fax: +49 30 185 420 2009

Contact points for joint aerial surveillance in the Baltic

Operational Contact Point / Emergencies (24/7)	
Central Command for Maritime Emergencies (CCME)	Phone: +49 30 185 420 1400 E-mail: mlz@havariekommando.de Fax: +49 30 185 420 2009

Contact points for places of refuge

Operational Contact Point / Emergencies (24/7)	
Central Command for Maritime Emergencies (CCME)	Phone: +49 30 185 420 1400 E-mail: mlz@havariekommando.de Fax: +49 30 185 420 2009

1.6. LATVIA (LV)

National Contact Points for spills at sea, on the shore and oiled wildlife response

Operational Contact Point / Emergencies (24/7)	
Spills at sea Maritime Rescue Coordination Centre (MRCC Riga)	Phone: +371 673 231 03 E-mail: sar@mrcc.lv Fax: +371 673 201 00
Spills on the shore Emergency Department Operative Management Board State Fire and Rescue Service of Latvia	Phone: +371 670 759 54 E-mail: ovp@vugd.gov.lv Fax: +371 670 759 55

Aerial surveillance – responsible authority

Operational Contact Point / Emergencies (24/7)	
Maritime Rescue Coordination Centre (MRCC Riga)	Phone: +371 673 231 03 E-mail: sar@mrcc.lv Fax: +371 673 201 00

Contact points for joint aerial surveillance in the Baltic

Operational Contact Point / Emergencies (24/7)	
Maritime Rescue Coordination Centre (MRCC Riga)	Phone: +371 673 231 03 E-mail: sar@mrcc.lv Fax: +371 673 201 00

Contact points for places of refuge

Operational Contact Point / Emergencies (24/7)	
Maritime Rescue Coordination Centre (MRCC Riga)	Phone: +371 673 231 03 E-mail: sar@mrcc.lv Fax: +371 673 201 00

1.7. LITHUANIA (LT)

National Contact Points for spills at sea

Operational Contact Point / Emergencies (24/7)	
Maritime Rescue Coordination Centre of Lithuanian NAVY	Phone: +370 46 391 257, +370 46 391 258 E-mail: mrcc@mil.lt Fax: +370 46 391 259

Aerial surveillance – responsible authority

Operational Contact Point / Emergencies (24/7)	
Maritime Rescue Coordination Centre of Lithuanian NAVY	Phone: +370 46 391 257, +370 46 391 258 E-mail: mrcc@mil.lt Fax: +370 46 391 259

Contact points for joint aerial surveillance in the Baltic

Operational Contact Point / Emergencies (24/7)	
Maritime Rescue Coordination Centre of Lithuanian NAVY	Phone: +370 46 391 257, +370 46 391 258 E-mail: mrcc@mil.lt Fax: +370 46 391 259

Contact points for places of refuge

Operational Contact Point / Emergencies (24/7)	
Maritime Rescue Coordination Centre of Lithuanian NAVY	Phone: +370 46 391 257, +370 46 391 258 E-mail: mrcc@mil.lt Fax: +370 46 391 259

1.8. POLAND (PL)

National Contact Points for spills at sea, on the shore and oiled wildlife response

Operational Contact Point / Emergencies (24/7)	
Maritime Rescue Coordination Center (MRCC Gdynia) Maritime Search and Rescue Service	Phone: +48 505 050 971, +48 58 620 55 51 E-mail: mrcc@sar.gov.pl Fax: +48 660 76 40

Aerial surveillance – responsible authority

Operational Contact Point / Emergencies (24/7)	
Maritime Office in Gdynia	Phone: +48 58 355 36 10, +48 58 355 36 11 E-mail: vts.centrum@umgdy.gov.pl Fax: +48 58 620 53 28, +48 58 620 53 63

Contact points for joint aerial surveillance in the Baltic

Operational Contact Point / Emergencies (24/7)	
Maritime Office in Gdynia	Phone: +48 58 21 61 62, +48 58 20 58 25 Fax: +48 58 20 67 43

Contact points for places of refuge

Operational Contact Point / Emergencies (24/7)	
Maritime Office in Gdynia - VTS Gulf of Gdansk	Phone: +48 58 355 36 10, +48 58 355 36 11 E-mail: vts.centrum@umgdy.gov.pl Fax: +48 58 20 67 43
Maritime Office in Szczecin - VTS Swinoujscie	Phone: +48 91 440 33 90, +48 91 321 62 03 E-mail: swinoujscietraffic@ums.gov.pl Fax: +48 91 321 6770

1.9. RUSSIA (RU)

National Contact Points for spills at sea, on the shore and oiled wildlife response

Operational Contact Point / Emergencies (24/7)	
Spill in the Gulf of Finland Maritime Rescue Coordination Centre (MRCC St. Petersburg)	Phone: +7 812 495 89 95 E-mail: mrcc@mail.pasp.ru Fax: +7 812 327 41 46
Spill in the South Baltic Sea Maritime Rescue Coordination Centre (MRCC Kaliningrad)	Phone: +7 4012 63 24 43 E-mail: mrckld@pasp.ru Fax: +7 4012 64 31 99

Aerial surveillance – responsible authority

Operational Contact Point / Emergencies (24/7)	

Contact points for joint aerial surveillance in the Baltic

Operational Contact Point / Emergencies (24/7)	

Contact points for places of refuge

Operational Contact Point / Emergencies (24/7)	
Gulf of Finland area Maritime Rescue Coordination Centre (MRCC St. Petersburg)	Phone: +7 812 495 89 95 E-mail: mrcc@mail.pasp.ru Fax: +7 812 327 41 46

1.10. SWEDEN (SE)

National Contact Points for spills at sea, on the shore and oiled wildlife response

Operational Contact Point / Emergencies (24/7)	
Swedish Coast Guard, NCP	Phone: +46 776 70 60 00 E-mail: lc@coastguard.se Fax: +46 31 297 395
MAS Maritime Assistance Service operational Contact Point 24 hours	
Joint Rescue Coordination Centre (JRCC Sweden) Swedish Maritime Administration / JRCC	Phone: +46 31 69 90 50 Email: jrcc@sjofartsverket.se Fax: +46 31 64 80 10
Spills on the shore	
Swedish Civil Contingencies Agency MSB Duty Officer	Phone: +46 54 150 150 E-mail: tib@msb.se Fax: +46 10-240 56 00
Oiled wildlife	
Swedish Environmental Protection Agency	Phone: +46 10 698 10 00 E-mail: registrator@naturvardsverket.se

Aerial surveillance – responsible authorities

Operational Contact Point / Emergencies (24/7)	
Swedish Coast Guard	Phone: +46 776 70 60 00 E-mail: lc@coastguard.se Fax: +46 31 297 395

Contact points for joint aerial surveillance in the Baltic

Operational Contact Point / Emergencies (24/7)	
Swedish Coast Guard Air Patrol	Phone: +46 155 46 71 10 alt.+46 776 70 60 00 E-mail: flygkoordinator@kustbevakningen.se

Contact points for places of refuge

Operational Contact Point / Emergencies (24/7)	
Joint Rescue Coordination Centre (JRCC Sweden) Swedish Maritime Administration / JRCC	Phone: +46 31 69 90 50 Email: jrcc@sjofartsverket.se Fax: +46 31 64 80 10

2. GUIDELINES FOR OPERATIONAL CO-OPERATION

The Contracting Parties undertake to maintain ability to respond to pollution incidents threatening the marine environment of the Baltic Sea area⁴. This ability shall include adequate equipment, ships and manpower prepared for operations on the shore, in coastal waters as well as on the open sea. The Contracting Parties shall, subject to their capabilities and availability of relevant resources, co-operate in responding to pollution incidents.

If a pollution incident occurs in a Contracting Party's response region, the Party shall make the necessary assessments of the situation and take adequate response action in order to avoid or minimize pollution. When such a spillage is likely to drift into a response region of another Contracting Party, that Party shall without delay be informed of the situation and the actions that have been taken⁵.

A Contracting Party is entitled to call for assistance from other Contracting Parties when responding to a pollution incident at sea or on the shore. Contracting Parties shall use their best endeavours to bring such assistance. They shall facilitate transport and movements of ships, aircraft, personnel, cargoes, materials and equipment engaged in responding to a pollution incident into, through and out of their territories⁶.

2.1. COMMAND STRUCTURE

The response operators are the following:

Lead Country (LC)

A Lead Country is a Contracting Party that has asked for assistance from other Contracting Parties for responding to a marine pollution incident. It is in charge of the joint operation, unless otherwise agreed.

Competent National Authority (CNA)

A Competent National Authority is the nationally responsible authority that is empowered to request and give international assistance (cf. [Chapter 1](#)). It has the overall control of a joint operation and all the pollution response measures for the same incident. Competent National Authorities of the assisting Parties provide the Lead Country agreed assistance, such as response vessels, Strike Teams and materials. For EU Member States, Emergency Response Coordination Centre (ERCC) of the European Commission can act as the CNA.

⁴ [Regulation 1 of Annex VII of the Helsinki Convention: General Provisions](#)

⁵ [Regulation 7 of Annex VII of the Helsinki Convention: Response Measures](#)

⁶ [Regulation 8 of Annex VII of the Helsinki Convention: Assistance](#)

Command Centre (CC)

A Command Centre is the command and control function that is undertaken by the appointed Competent National Authority of the Lead Country. The CC is an operative body that has the responsibility for and supervision over the personnel, equipment and facilities. The CC takes care of communication, command, control, intelligence, forecasts and other joint arrangements in connection herewith. There can be separate Command Centres that plan, order and coordinate at sea and on the shore response.

Response Commander (RC)

A Response Commander is the person in charge of the overall operational control of a pollution response operation. The RC is normally located in the Command Centre. He/she shall e.g. give administrative, operational and logistic support to the units of the assisting Parties and keep a firm contact with the Competent National Authorities of the Parties.

On the Shore Response Commander (SRC)

An On the Shore Response Commander gives tasks to the assisting Strike Teams on the shore. The designated SRC from the Lead Country is in charge of the tactical command of an on the shore response operation. The SRC gets tasks from the Response Commander.

Liaison Officer (LO)

The requesting Party will appoint one or several Liaison Officer(s). The LO is for example the link between the RC and the assisting Party. Depending on the scale of the incident and of the provided assistance, the LO can be based in a response vessel, with a Strike Team or in the Command Centre.

Advisory Body

An Advisory Body may assist the Response Commander. Advisory Body consists of the representatives of the cooperative National Authorities. The Liaison Officers from assisting Parties and regional authorities may be invited as members or visiting experts of the Advisory Body.

EU Civil Protection Team (EUCPT)

The Lead Country may request support from the EU Civil Protection Team EUCPT. The EUCPT provides advise or support within specific areas of a response operation while acting as liaison to the EU Emergency Response Coordination Centre (ERCC) in Brussels. The EUCPT can be integrated into Lead Country's Advisory Body or remain as an external advisor.

Supreme On-Scene Commander (SOSC)

A designated Supreme On-Scene Commander from the Lead Country is in charge of the tactical command of an at sea response operation. The SOSC gets tasks from the Response Commander and is normally based at sea in the commanding vessel.

National Coordinator (NC)

A National Coordinator is the link between the assets sent to help and the headquarters of the assisting Party. The NC is operating under the command of the RC and has no commanding role.

Each assisting Party will appoint an NC. The NC keeps the organizations in his/her country up to date of the progress regarding the recovery work and also asks for extra assets - such as new crew members - from the headquarters of his/her country.

As regards EMSA's response assets, the EMSA Maritime Support Services (MSS) acts as the NC.

Strike Team (ST)

The SOSOC defines the operational response vessel groups that are called Strike Teams. The SOSOC nominates a leader to each ST and gives each team their tasks and working area. The Strike Team Leader defines the tasks of the different vessels in the ST.

STs are not only vessels, they can also operate on the shore. The SRC nominates the Strike Team Leader.

Flight Coordinator (FC)

A Flight Coordinator may command and control flight operations for surveillance and/or transport in the Command Centre. Leaders of this kind of special joint functions and separate units may be directly under the RC or the SOSOC.

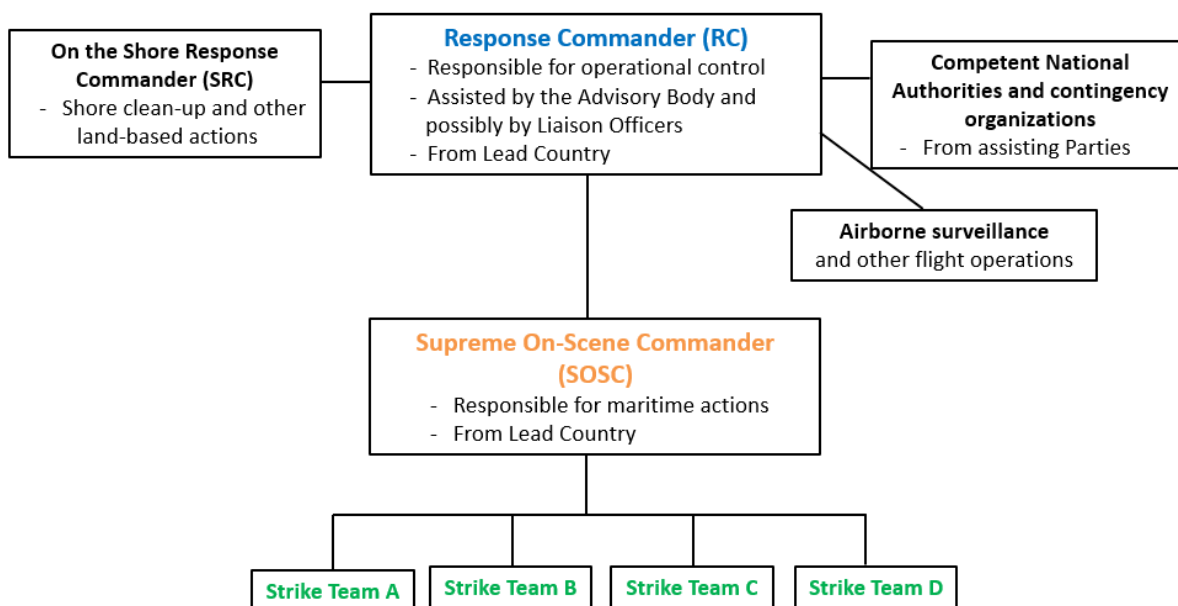

Figure 1. Command structure for joint response operations.

2.2. OPERATIONAL COMMUNICATION

The Contracting Parties involved in a joint operation shall communicate in all relevant levels of co-operation. They shall keep each other informed about the pollution incidents, their extent and the polluted area. They shall also share information on the actions taken and their efficiency. In operations in border areas the neighbouring Contracting Parties should be consulted, inter alia, when deciding which areas should be prioritized in the operation.

The reporting procedures detailed in [Chapter 5](#) apply to normal communication between Competent National Authorities responsible for receiving and dispatching pollution reports (POLREP). The reporting procedures also apply to request and facilitation of international assistance (POLFAC) in joint response operations.

Working language for joint response operations is English, if not otherwise agreed by the Response Commander.

International communication between Contracting Parties

The Competent National Authority shall acknowledge and write the formal POLREP messages warning and informing on an incident, as well as requesting and offering assistance. The messages shall be delivered by the operational Contact Points listed in [Chapter 1](#). The POLREP messages should be submitted using SafeSeaNet and CECIS Marine Pollution, respectively, or other available communication means such as e-mails.

The Lead Country shall send a daily progress report to the other Contracting Parties during a joint response operation. Any matter of importance for joint efforts should be confirmed as soon as possible. Urgent official or informal contacts may be made through any available communication means.

Communication between assisting Party and its units

An assisting Party may communicate directly with its NC. It is also possible to communicate via the CC of the Lead Country or the LOs of the assisting Party.

Communication between RC, CC, SOSC, SRC and FC

The role of the Command Centre is performed by the country within whose response region the operation takes place (Lead Country). The CC is normally located ashore.

It is the responsibility of the Lead Country to establish and maintain communication between the RC, CC, SOSC, SRC and FC. Communication is established directly from the CC to the SOSC via any available communication means (e.g. radio, telephone, mobile phone etc.), depending on the facilities and the internal organization within the Lead Country.

The CC may communicate directly or via FC with aircraft, using aviation frequencies designated by the respective Flight Information Region. The SOSC may communicate directly with an aircraft using aviation frequencies, if available.

Maritime patrol aircraft may communicate directly with vessels using maritime VHF radios. Remote sensing results gained by a surveillance flight may be transferred from an aircraft directly to the CC and to the SOSC using data transmission systems, if available.

Communication between SOSC and Strike Teams

The communication between the SOSC and the Strike Teams is performed on VHF frequencies designated by the RC.

Communication inside a Strike Team

Communication between the units in a Strike Teams is carried out on a VHF frequency designated by the RC. Tetra radios can be used as well for the communication between the units in a Strike Team.

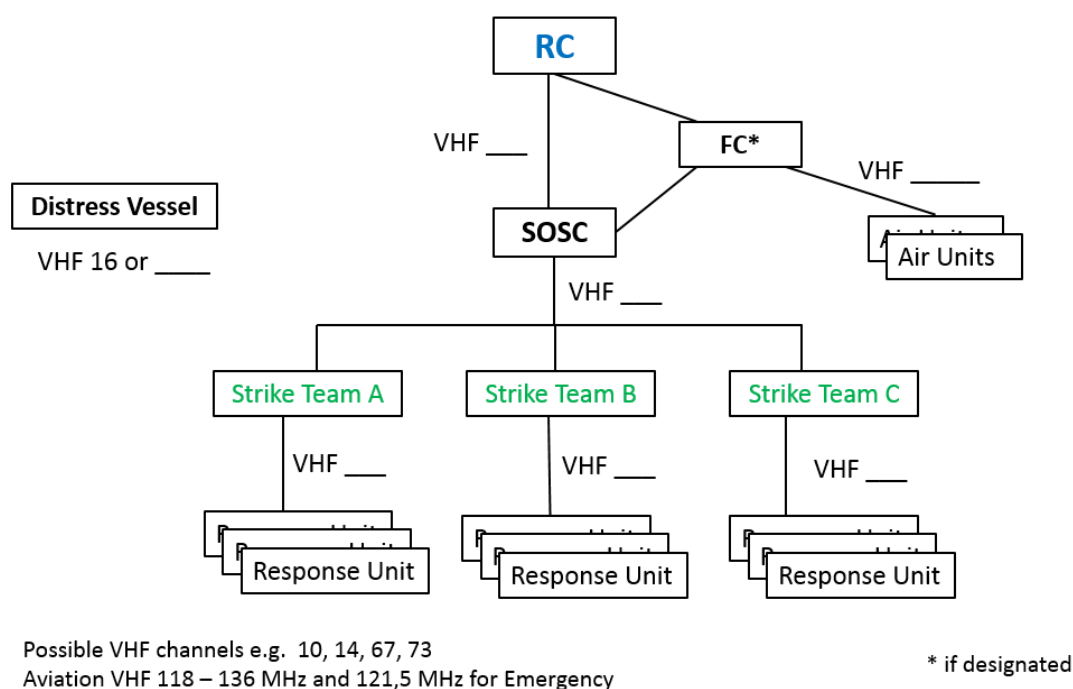

Figure 2. Operational communications plan for joint response operations at sea.

2.3. OTHER PRINCIPLES FOR OPERATIONAL CO-OPERATION

Aerial surveillance

Aerial surveillance is a tool for co-operation on reconnaissance of pollution. It is anticipated that the Lead Country will initiate surveillance of the spill within its own response region and communicate the results from this surveillance activity to other Contracting Parties bordering the Lead Country's response region. If a spill spreads into two or more response regions, the affected Contracting Parties should agree on a coordinated surveillance of the spill area. This is to avoid duplication of the surveillance efforts. The Lead Country may also ask aerial

surveillance assistance from other Contracting Parties. Assisting surveillance aircrafts might operate from a national airport or from an airport of the Lead Country.

Drift forecasting

The Seatrack Web (STW) is the official HELCOM drift model. [HELCOM Recommendation 24/7](#)⁷ is also applicable to operational co-operation.

Satellite surveillance

EMSA is responsible for the coordination of satellite surveillance in EU region. EMSA will on request provide the Lead Country with satellite coverage of a polluted area. That information is available for the requesting Party as well as for other EU Member States and coastal EFTA/EEA countries.

Use of dispersants

The employment of dispersants should be taken with due regard to the neighbouring countries' regulations regarding their use. Mechanical means are the preferred response measures and dispersants may only be used in exceptional cases⁸, after authorization has been granted in each individual case. If the Lead Country decides to use dispersants, it shall inform other Contracting Parties on this decision. Furthermore, [HELCOM Recommendation 22/2](#)⁹ should be taken into account.

Use of HELCOM Response Grid

Use of HELCOM Response Grid is explained in [Annex 9](#).

Health and safety standards

Foreign groups and volunteers will have to comply with the standards for health, safety and environment (HSE) of the Lead Country. These standards will be made available to invited groups in a communicable format, e.g. translated into English if possible. The adoption of a common set of HSE standards would truly facilitate the smooth integration of experts.

There are specific requirements for dealing with oil pollution. These include protocols and training with regards to:

- maintenance of safe working conditions and procedures
- understanding of occupational health
- understanding of potential hazards of the work
- wearing of adequate personal protective equipment (PPE)
- practice of good personal hygiene
- cautious behaviour in natural hazardous areas
- minimizing polluted waste and secondary pollution.

⁷ HELCOM Recommendation 24/7: Further Development and Use of Drift Forecasting for Oils and Other Harmful Substances in the Baltic

⁸ [Regulation 7 of Annex VII of the Helsinki Convention: Response Measures](#)

⁹ HELCOM Recommendation 22/2: Restricted Use of Chemical Agents and Other Non-mechanical Means in Oil Combatting Operations in the Baltic Sea Area

Transfer of the operational control

The Contracting Party that has been in charge of the joint operation may request another Party to take over the supreme command, if a substantial part or serious threat of an oil pollution moves/has moved into the zone of another Party.

The timing of the shift of operational command and control should be negotiated between the two countries in question, taking due regard to the overall picture and any possible trends in its development. The countries in question will further have to settle the number of units and the amount of equipment that could be placed at the disposal of the new Lead Country. They also have to agree on how the response operation should be continued.

3. REQUESTING AND PROVIDING ASSISTANCE

Requesting and providing assistance for oil or chemical spill response and a place of refuge are based on the Helsinki Convention, [HELCOM Recommendation 31E/5¹⁰](#), international guidelines within the International Maritime Organization (IMO) and other international frameworks for co-operation.

HELCOM Member States have concluded bi- and trilateral agreements (see [Annex 3. Bi- and Trilateral Agreements](#)). In addition to that, in a joint operation the requesting and the assisting Parties should make a confirmation concerning the proper dispatching of the resources provided. The confirmation concerns also a survey and an assessment of consumed stocks, including damaged or contaminated equipment.

3.1. OBLIGATIONS OF THE REQUESTING PARTY

In case of a major oil or chemical pollution incident at sea or on the shore, a request for assistance from a Contracting Party (requesting Party) can be addressed to one or more Contracting Parties (assisting Party/Parties). The request for assistance shall be made by the Competent National Authority of the requesting Party and addressed to the Competent National Authority of the assisting Party. Competent National Authorities are listed in [Chapter 1](#) of this Manual.

Requests shall be made using the POLREP format. When writing the POLREP, the requesting Party should identify as precisely as possible the specific tasks to which international assistance is needed.

The requesting Party shall take into account the following points:

Written confirmation

If the request is initially given by phone the request shall always be followed by a written confirmation by a Competent National Authority of the requesting Party.

Clearly defined tasks and forms of assistance

The requesting Party shall inform the Competent National Authority of the assisting Party on the tasks of the assisting Party. The tasks have to be clearly defined.

A request of assistance can consist of:

- specified equipment only
- personnel with special expertise

¹⁰ HELCOM Recommendation 31E/5: Mutual Plan for Places of Refuge in the Baltic Sea Area

- pollution response vessels
- complete strike teams
- aerial surveillance
- other types of specified equipment with trained personnel.

Strike teams at sea can consist of:

- response vessels and crews
- work boats and crews
- equipment for
 - o communication
 - o personnel safety (protective suits, breathing apparatus etc.)
 - o booms, skimmers, storage tanks and other specialized equipment to respond to at sea pollution.

Strike teams on the shore can consist of:

- oiled shore response teams
- oiled wildlife treatment teams
- oiled wildlife catching teams
- equipment for
 - o communication
 - o personnel safety (protective suits, breathing apparatus etc.)
 - o specialized equipment for responding to on the shore pollution
 - o specialized equipment for oiled wildlife response.

Integration of the assisting Party units in the response structure

The requesting Party shall keep close contact with the command organizations of the assisting Parties. This is to secure that the assisting Party units can be integrated in the response structure of the requesting Party.

Equipment and personnel from the assisting Party are assigned under the command of the Response Commander appointed by the requesting Party. Equipment or personnel may be appointed under the command of other authorities or organizations of the requesting Party with the approval of the assisting Party.

Liaison Officer (LO)

The requesting Party shall be prepared to appoint Liaison Officers to act as a link between the Response Commander and the assisting Party.

Provision of means for communication

The requesting Party has to provide means for communication between the Competent National Authority of the assisting Party, the Liaison Officers and the units, if needed.

Administrative, logistic and other necessary support

The requesting Party is responsible for providing the assisting Party units e.g. all necessary domestic arrangements for border crossing and accommodation of the assisting resources.

The requesting Party is also responsible for providing maintenance facilities e.g. for equipment repair.

Arrangements for collected oil and oiled wildlife

The requesting Party is responsible for the necessary arrangements for:

- collected oil or other hazardous or noxious substance (HNS)
- collected contaminated soil
- collected rescued or dead oiled wildlife.

3.2. OBLIGATIONS OF THE ASSISTING PARTY

The assisting Party shall keep in mind the following points:

Information on extent of assistance

The assisting Party shall use its best endeavours to bring about the requested assistance and to decide to which extent the request can be complied with.

Information on financial consequences

The assisting Party shall be prepared to give information on the cost of the offered assistance.

National Coordinator (NC)

Each assisting Party will appoint an NC, who is the link between the assets sent to help and the home offices of the assisting Party.

Team Leader

Each assisting Party will appoint a Team Leader for each Strike Team on the shore. The SOSOC will appoint a Team Leader for each Strike Team at sea (see [Chapter 2](#)).

Information on termination of assistance

If the circumstances so demand, the assisting Party can fully or partly terminate its assistance. Information on the termination shall be communicated to the Competent National Authority of the requesting Party.

3.3. REQUESTING FOR A PLACE OF REFUGE FROM A NEIGHBOURING CONTRACTING PARTY

Request for a place of refuge from a neighbouring Contracting Party should only be submitted if national options have been fully explored, leading to a conclusion that due to different circumstances there is no suitable place of refuge in its own area. Granting a place of refuge in a neighbouring Contracting Party would be the only solution to ensure ship, coastal and traffic safety and to avoid or limit pollution, or the risk of it¹¹. Financial considerations,

¹¹ [HELCOM Recommendation 31E/5: Mutual Plan for Places of Refuge in the Baltic Sea Area](#)

commercial reasons or lack of response resources should not be regarded as a sufficient reason to request a place of refuge from another Contracting Party.

In case the requested Party is not in a position to offer a place of refuge, the underlying reasons for this decision should be communicated to the requesting Party.

A request by telephone shall always be followed by a written confirmation by a Competent National Authority of the requesting Party. The request shall be made by the designated Competent National Authority which has the power to take independent decisions concerning accommodation of ships in need of place of refuge. The request shall be addressed to the operational Contact Point for places of refuge as listed in [Chapter 1](#). The existing format for pollution reporting (POLREP) is to be used when requesting assistance.

The requesting Party when contacting the requested Party should provide all information on their reasons for not accommodating the vessel in their own area. The requesting Party should also provide information according to IMO “Guidelines on Places of Refuge for Ships in Need of Assistance” (Resolution A.949(23) or as amended), including information on:

- ship details
- seaworthiness of the ship (in particular buoyancy, stability, availability of means of propulsion and power generation, docking ability etc.)
- nature and condition of cargo, stores, bunkers, hazardous and noxious substances (HNS), including the quantities
- pollution caused by the ship
- whether the master is still on board
- number of other crew and/or salvors and other persons on board, and an assessment of human factors, including fatigue
- whether the ship is insured, identification of the insurer and the limits of liability available
- provisions of the financial security required
- commercial salvage contracts already concluded by the master or company of the ship
- information on the intention of the master and/or salvor
- any measures already taken.

Complementing information including a SITREP template and guidance for EU Member States can also be found in [Places of Refuge – EU Operational Guidelines](#).

Unless otherwise agreed, the costs of the action taken by a Contracting Party at the request of another Party shall be fairly calculated according to the law and current practice of the assisting Party concerning the reimbursement of such costs.

In a place of refuge situation, the authorities of the Contracting Parties could in advance bilaterally discuss ways of fair sharing of costs not met by the international compensation regime, and without prejudice to the polluter pays principle. The general principles of costs of assistance in a pollution incident are described in [Chapter 9.1](#).

4. ADMINISTRATIVE AND ORGANIZATIONAL SUPPORT OF THE REQUESTING PARTY

The HELCOM Response Manual sets the framework regarding administrative and organizational matters. The basic principles are implemented by each Contracting Party into their own national structures.

4.1. GENERAL PRINCIPLES

Preparedness for international assistance

International formalities and administrative regulations differ from one Contracting Party to another. To avoid delays in operational assistance situations as well as in exercises, Contracting Parties should be prepared to receive international assistance and to facilitate cross-border movements. This applies to:

- state-owned aircraft
- state-owned ships and vehicles
- equipment
- personnel and experts
- oily waste
- oiled animals
- privately owned resources under governmental contract.

Each Contracting Party should prepare in advance a concept and a sufficient plan for receiving assistance smoothly. They contain e.g. checklists of important issues that the requesting Party must be able to provide to the assisting Party. [EU Host Nation Support in Annex 4](#) can be used when compiling such national checklists.

**THE REQUESTING PARTY SHOULD BE PREPARED TO PROVIDE THE ASSISTING UNITS FOR
INSTANCE WITH:**

- *transport support*
- *administrative support*
- *logistic support*
- *communication means*
- *accommodation*
- *meals*
- *protective clothing*
- *medical treatment*
- *Liaison Officer.*

Complementing information and guidance is available in the [EU Host Nation Support Guidelines \(EU HNSG\)](#) which aims at assisting the affected States to receive international assistance in the most effective and efficient manner.

Customs matters

Authorities which are likely to be involved in joint operations should observe instructions in the Manual. The Manual outlines the procedures to be followed in joint operations, involving customs formalities.

Normally there is a customs duty to be paid on goods that are used in joint operations. If the goods are not to be re-exported (e.g. dispersants), they should enjoy relief from import duties. If the goods are to be re-exported (e.g. mechanical recovery means), they should be granted temporary importation arrangements.

The customs authorities should be invited to take part in the preparation of the contingency plans for joint operations. They can help with problems of formalities in both dispatching and receiving assistance. When possible, documents should be prepared in advance. As well as customs documents, detailed lists of goods to be transported could be prepared before the operation begins.

Civil liability for injuries or damage

Disputes over injuries or damages should be settled according to the rules of civil liability. Responsibility for the payment of costs would rest with the requesting Party, except in cases of ill intent, grave fault or gross negligence. The requesting Party should always be informed when a dispute with a third party is to be settled before a court of law. In such cases within the territory of the requesting Party, the requesting Party should help the assisting Party or person concerned.

Medical treatment

The requesting Party should always make provision for the medical treatment of personnel of the assisting Party, when necessary or wanted.

Accommodations and meals

As a general rule it is the responsibility of the requesting Party to arrange accommodation and meals for the assisting Party's personnel, when necessary or wanted.

Equipment and repairs

The requesting Party should help the assisting Party to the best of its ability with maintenance and repairs of equipment which cannot be carried out by personnel of the assisting Party.

Press requests

In order to protect the assisting and other personnel from uncontrolled press requests, the requests should be controlled centrally through the requesting Party. Media requests addressed directly to the assisting Party or its forces should be coordinated with the requesting Party.

Exercises

Countries should relate to exercises with the same seriousness as if it was a live emergency situation with crucial need for assistance.

4.2. ISSUES TO BE CONSIDERED IN JOINT OPERATIONS AT SEA

There are certain matters that the requesting Party needs to pay attention to in response operations at sea:

Clearances and permissions of aircraft, vessels and response equipment

The Contracting Parties should facilitate the granting of all clearances and permissions required for aircraft, vessels and equipment of other Contracting Parties to carry out the mission in their territory. This applies to joint pollution response operations, aerial surveillance operations and joint exercises.

Close-knit leadership of the response vessels

A close co-operation and leadership between the response vessels and the SOSC of the requesting Party is necessary for the success of the operation.

Conditions of work and legislation

There are no legislative problems with the crew that works on vessels, because vessel and crew safety is under the responsibility of the ship master. Laws and regulations of the flag state related to crew safety and working hours are to be applied.

Smaller response vessels that cannot operate 24/7 must have the opportunity to enter a port near the response area to allow the crew to have necessary rest periods. These ports should not be publicly accessible. It must be kept in mind that these vessels may be contaminated.

Logistical requirements

It should be agreed whether the requesting Party will set up a central body that bundles and processes all logistical requirements, or whether they are the responsibility of the assisting Parties. Port stays of contaminated response vessels should be avoided as far as possible.

It might be useful to set up a shuttle service to the response area in order to provide the ships with equipment, personnel and spare parts. Large ships can easily stay at sea for a few days

and they can also be supplied there. Smaller units with less crew are in a different situation, as they must enter a port after one working day in order for the crew to have prescribed rest periods.

Protected area for vessels to retreat

A protected area should be established near the operational area where response vessels can retreat in case of a bad weather. It should be noted that these vessels are contaminated and there is a risk that the contamination will spread to the environment.

Storage tanker

In order to avoid response vessels' long journeys with time loss and contamination of ports and coastlines, a storage tanker should be arranged by the Lead Country in the operation area. In particular the smaller response vessels need at early stages of the operation additional tank capacity in which the recovered oil can be transferred to.

4.3. ISSUES TO BE CONSIDERED IN JOINT OPERATIONS ON THE SHORE

For on the shore operations the requesting Party needs to take into account e.g. the following issues:

On the Shore Liaison Officer

An On the Shore Liaison Officer should meet the assisting Party at the border or in a location agreed by the requesting and the assisting Party. He/she should be able to communicate with the assisting personnel in a language known to them.

Assistance vehicles' special taxes and traffic fees

The requesting Party should use all its influence to renounce the fees or special taxes arising at border passage. Information about national traffic regulations that stipulate conditions for using vehicles could be given to the assisting Party at the border, when necessary.

Conditions of work and legislation

The Response Commander is in charge of the entire operation. The captains are responsible for the working conditions and safety on their ships.

It should be the responsibility of the Response Commander and the On the Shore Response Commander to ensure that the national rules of the requesting Party are observed for personnel under his/her command. It should be the responsibility of the National Coordinator to ensure that the personnel under him/her complies with the national rules of the assisting Party.

As regards assistance on the shore, there would probably be difficulties in waiving the national laws of the requesting Party. It would also be difficult to require the assisting Party to comply with rules other than those applicable to them nationally. However, on the shore the respective authorities of the requesting Party are responsible for informing the Strike Team Leaders about relevant labour protection regulations, as well as of relevant legislation of the requesting Party.

5. POLLUTION REPORT

The pollution reporting system is for use between Contracting Parties for exchanging information when pollution of the sea has occurred or when a threat of such is present. The POLREP system is developed by the International Maritime Organization (IMO) and it has been published by IMO in the Manual on Oil Pollution Section II - Contingency Planning¹².

“POL” indicates that the report deals with all aspects of pollution (oil and other harmful substances, i.e. chemicals) and “REP” tells that it is a report. The report should be in English.

5.1. PARTS OF THE REPORTING SYSTEM

The POLREP is divided into three parts:

Part I or POLWARN (figures 1 - 5)	POLLution WARNing	gives information or warning of pollution, potential pollution or threat of pollution.
Part II or POLINF (figures 40 - 60)	POLLution INFormation	gives detailed supplementary information as well as situation reports.
Part III or POLFAC (figures 80 - 99)	POLLution FACilities	deals with requests for oil spill response facilities or resources as well as operational matters.

The division into three parts is only for identification purposes. For this reason consecutive figures are not used. This enables the addressee/addressees to recognize merely by looking at the figures whether dealing with:

- Part I (1 -5)
- Part II (40 - 60)
- Part III (80 - 99).

All POLREP message types should contain all relevant lines from all three parts of the POLREP message format.

When Part I is used as a warning:

- it should be transmitted to the operational Contact Point/Emergencies of those Contracting Parties which may be affected
- it should be transmitted to the Secretariat of the Helsinki Commission
- it shall always be sent with the traffic priority URGENT
- it should always be followed up by a supplementary POLREP or be cancelled.

¹² The 2018 revision has the product code IB560E and ISBN 978-92-801-1666-3.

Part II is used to give detailed information about the incident.

Part III is used for matters related to assistance. A POLREP including numbers from Part III can, if deemed necessary, be transmitted with the traffic priority URGENT.

The reporting response authority shall indicate in the POLREP message when no more operational communication on that particular incident can be expected. This is indicated by adding word FINAL in the message identifier.

The POLREP can be e-mailed to the operational Contact Points of the Contracting Parties.

For Parties which are EU Member States incident reporting can be done by using the EU SafeSeaNet (SSN) system (i.e. POLWARN, POLINF) and the Common Emergency Communication and Information System for Marine Pollution - CECIS MP¹³ (i.e. POLFAC).

5.2. IDENTIFICATION OF THE REPORTS

The national identifiers are the following:

<i>Denmark</i>	<i>DK</i>
<i>Estonia</i>	<i>EE</i>
<i>European Commission</i>	<i>EC / EMSA</i>
<i>Finland</i>	<i>FI</i>
<i>Germany</i>	<i>DE</i>
<i>Latvia</i>	<i>LV</i>
<i>Lithuania</i>	<i>LT</i>
<i>Poland</i>	<i>PL</i>
<i>Russia</i>	<i>RU</i>
<i>Sweden</i>	<i>SE</i>

The receiving response authority should be in a position to check if all the reports of the incident in question have been received. Each single report should be identifiable. The identification is done by using a serial number preceded by a national identification, e.g. "DK 1/2".

The number before the stroke indicates the incident to which the report refers. The number following the stroke points out the actual number of reports which have been originated on the incident in question.

Examples:

¹³ The SSN Pollution Reporting System established by VTIMS Directive 2002/59/EC, as amended, is for use between authorities in EU Member States to exchange information, when pollution of the sea has occurred or when a threat of such is present. SSN has been linked to CECIS to allow relevant data entered in SSN to be automatically fed into CECIS Marine while creating a request for assistance.

- "DK 1/1" thus indicates the first report of the incident in question.
- "DK 1/2" means the second report of the same incident.
- "DK 1/5 FINAL" is the fifth and final report concerning the first pollution.
- "DK 1/2 now splitting into DK 2 and 3" should be indicated in the last report from the incident 1, if the pollution splits up in clearly separate patches (in this example two patches).
- "DK 2/1" and "DK 3/1" will then be the numbers for the first reports from the two patches (originating from the incident first reported). Forth running numbering could then be used.

It is important to keep the receivers of POLREP informed of all the transmitted reports. For this reason the response authority sending the POLREP must after the serial number include information on the recipients of the earlier transmitted POLREPs, for instance:

"DK 2/5 - DK 2/1 for DE and SE"
DK 2/2 for DE"
DK 2/3 for SE"
DK 2/4 for DE and SE"

POLREPs containing "ACKNOWLEDGE" (figures 5, 60 and 99) should be acknowledged as soon as possible by the response authority addressed. It is emphasized that ACKNOWLEDGE made by the response authority addressed should be with reference to the serial number in question, e.g. "your DK 2/1". The serial number used by the transmitting response authority is to be used as reference in the answer (cf. above), when answering a POLREP.

If the POLREP is used in exercises, the POLREP shall start with the word EXERCISE and finish with the word EXERCISE repeated three times. The same procedure should also be used for the following reports which deal with the exercise.

5.3. DETAILED INFORMATION OF THE REPORTING SYSTEM

Chapters 5.1 and 5.2 give a description of the POLREP system in general terms. [Annex 5](#) contains a reporting template and [Annex 6](#) includes sample messages illustrating how the system could be used for different purposes. This chapter focuses on detailed explanations of the report headings.

HEADING	REMARKS
URGENT	Traffic Priority to be used when POLREP is used as POLWARN or POLFAC.
DTG (date time group)	<ul style="list-style-type: none"> - Day and time for drafting of the POLREP. - Always 6 figures. - Can be followed by month indication. - The time should be given in UTC (Coordinated Universal Time).
POLREP	The identification of the report. Can contain up to 3 main parts: PART I (POLWARN), PART II (POLINF) and PART III (POLFAC).
NATIONAL IDENTIFIER AND SERIAL NUMBER	The identification of the report by using a national identifier followed by a stroke system (cf. Chapter 5.2).

ITEM NUMBER	REMARKS
1. DATE AND TIME	<ul style="list-style-type: none"> - Day of the month and time of the day when the incident took place. - Time of the observation if the cause of the pollution is not known. - Time should be stated in UTC with 6 figures, for example 091900 (i.e. the 9th of the relevant month at 1900 UTC).
2. POSITION	<p>The main position of the incident:</p> <ul style="list-style-type: none"> - in latitude and longitude in degrees and minutes, or - by bearing and distance from a location known to the addressee.
3. INCIDENT	<p>The nature of the incident, such as:</p> <ul style="list-style-type: none"> - BLOWOUT - TANKER GROUNDING - TANKER COLLISION - OIL SLICK etc.

- 4. OUTFLOW**
- Nature of the pollution such as CRUDE OIL, CHLORINE, DINITROL, PHENOL etc.
 - Total quantity in tonnes of the outflow or/and the flow rate.
 - Risk for further outflow.
 - If there is no pollution, but a pollution threat, the words NOT YET followed by the substance, e.g. "NOT YET FUEL OIL".
-
- 5. ACKNOWLEDGE** When this figure is used, the POLREP should be acknowledged as soon as possible by the response authority addressed, e.g. "YOUR RU 1/3 ACKNOWLEDGED".
-
- 40. DATE AND TIME** Relates to the situation described in figures 41 to 60, if it varies from figure 1.
-
- 41. POSITION AND/OR EXTENT OF POLLUTION ON/ ABOVE/ IN THE SEA**
- The main position of the pollution (if other than indicated in figure 2):
- in latitude and longitude in degrees and minutes, or
 - by bearing and distance from a location known to the receiver.
- Estimated amount of pollution (if other than indicated in figure 4), for instance:
- size of polluted areas
 - number of tonnes of oil spilled
 - number of containers, drums etc. lost.
- Indicates length and width of slick given in nautical miles and in tenth of nautical miles (if not indicated in figure 2).
-
- 42. CHARACTERISTICS OF POLLUTION**
- Type of pollution, for instance:
- type of oil with viscosity and pour point
 - packaged or bulk chemicals
 - sewage.
- For chemicals give proper name or UN-number, if known. For all, give also appearance, for instance:
- liquid
 - floating solid
 - liquid oil
 - semi-liquid sludge
 - tarry lumps
 - weathered oil
 - discolouration of sea
 - visible vapour.
- Any markings on drums, containers etc. should be given.

For describing the oiling of the shore, nomenclature in [Annex 7](#) can be used.

43. SOURCE AND CAUSE OF POLLUTION

For instance from vessel or other undertaking. If from vessel, say whether as a result of deliberate discharge or casualty. If the latter, give brief description.

Where possible, give:

- name
- type
- size
- call sign
- nationality
- port of registration of polluting vessel.

If vessel is proceeding on its way, give:

- course
- speed
- destination.

44. WIND DIRECTION AND SPEED

Indicates wind direction and speed in degrees and m/sec. The direction always indicates from where the wind is blowing.

45. CURRENT DIRECTION AND SPEED

Indicates current direction and speed in degrees, knots and tenths of knots. The direction always indicates the direction in which the current is flowing.

46. SEA STATE AND VISIBILITY

Sea state indicated as wave height in meters. Visibility in nautical miles.

47. DRIFT OF POLLUTION

Indicates drift course and speed of pollution in degrees, knots and tenths of knots. In case of air pollution (gas cloud) drift speed is indicated in m/sec.

48. FORECAST OF LIKELY EFFECT OF POLLUTION AND ZONES AFFECTED

The forecast could be given as e.g. estimated time for the pollution to hit beaches, or results of mathematical drift models.

49. IDENTITY OF OBSERVER/REPORTER

Indicates who has reported the incident. If a ship, give:

- name
- home port
- flag
- call sign.

IDENTITY OF

Ships on scene can also be indicated under this item

SHIPS ON SCENE	(by name, home port, flag and call sign), especially if the polluter cannot be identified and the spill is considered to be of recent origin.

50. ACTION TAKEN	Any action taken for the disposal of the pollution.

51. PHOTOGRAPHS TAKEN	Indicates if photographs or samples from the pollution have been taken. Contact details of the sampling authority should be given.

52. NAMES OF OTHER STATES AND ORGANIZATIONS INFORMED	

53. REPORT ON OILED WILDLIFE	Indicates: <ul style="list-style-type: none"> - date and time of the report - amount and state of oiled wildlife - oiled species - position of observation and if at sea and/or on the shore - source of pollution (if possible).

54. ACTION TAKEN ON OILED WILDLIFE	Any action taken for collection and/or treatment of oiled wildlife.

55. FORECAST OILING OF WILDLIFE	Forecast should be given of estimated time of the pollution arriving in wildlife sensitive area(s).

56. EVIDENCE TAKEN FROM OILED WILDLIFE	Have samples of e.g. oiled feathers been taken?

57. - 59. SPARE FOR ANY OTHER RELEVANT INFORMATION	Examples: <ul style="list-style-type: none"> - results of sample photographic analysis - results of inspections by surveyors - statements of ship's personnel.

60. ACKNOWLEDGE	When this figure is used, the POLREP should be acknowledged as soon as possible by the Competent National Authority.

80. DATE AND TIME	Number 80 is related to the situation described next if it varies from figures 1 and/or 40.

81. REQUEST FOR ASSISTANCE	Type and amount of assistance required in form of: <ul style="list-style-type: none"> - specified equipment - specified equipment with trained personnel - complete Strike Teams

- personnel with special expertise with indication of requested country.

82. COST Information on cost of requested assistance to the requesting country.

83. PRE-ARRANGEMENTS FOR THE DELIVERY OF ASSISTANCE Information concerning customs clearance, access to territorial waters etc. in the requesting country.

84. WHERE ASSISTANCE SHOULD BE RENDERED TO AND HOW Information concerning the delivery of assistance, for instance:

- rendezvous at sea with information of frequencies to be used
- call sign and name of the Supreme On-Scene Commander of the requesting country or
- land-based authorities with telephone number, e-mail address and contact persons.

85. NAMES OF OTHER STATES AND ORGANIZATIONS Only to be filled in if not covered by figure 81, e.g. if further assistance is later needed by other Contracting Parties.

86. CHANGE OF COMMAND The Contracting Party that has exercised the supreme command of the operation may request the other Party to take over the supreme command, if a substantial part or serious threat of an oil pollution moves/has moved into the zone of the other Contracting Party.

87. EXCHANGE OF INFORMATION When a mutual agreement has been reached between two Parties on a change of supreme command, the Party transferring the supreme command should give a report on all relevant information pertaining to the operation to the Party taking over the command.

88. REQUEST FOR WILDLIFE RESPONSE ASSISTANCE Type and amount of assistance required, for instance:

- specific equipment
- trained personnel
- complete Strike Teams
- use of a rehabilitation centre abroad.

89. PRE-ARRANGEMENT FOR WILDLIFE RESPONSE ASSISTANCE

- Custom clearance if animals need to be transported abroad.
- Custom clearance of mobilized equipment and units.

**90. WHERE WILDLIFE
ASSISTANCE SHOULD
BE RENDERED TO**

- Information concerning the delivery of the assistance, e.g. delivery address.
 - Contact details of the wildlife response coordination unit.
-

**91. - 98. SPARE FOR ANY
OTHER RELEVANT
REQUIREMENTS OR
INSTRUCTIONS**

99. ACKNOWLEDGE

When this figure is used, the POLREP should be acknowledged as soon as possible by the Competent National Authority.

6. CO-OPERATION IN AERIAL SURVEILLANCE

The purpose of aerial surveillance over the Baltic Sea area is to detect and register spills of oil and other harmful substances which can threaten the marine environment. Within the framework of the Helsinki Convention it has been decided to establish close co-operation in airborne surveillance¹⁴. All Contracting Parties have agreed to participate in the collaboration to the best of their ability.

Close co-operation will be achieved by:

- regular national flights
- setting up special flights such as Coordinated Extended Pollution Control Operation (CEPCO) Flights
- standardization of the reporting formats and exchange of information between the Contracting Parties
- working together in improving existing systems and developing new techniques to enhance the information obtained.

The HELCOM Informal Working Group on Aerial Surveillance (IWGAS)¹⁵ is responsible for the co-operation. IWGAS is also responsible for coordination of the satellite-based oil spill surveillance, as well as evaluation of its results and operational effectiveness.

Each Contracting Party operates at least in its own response region during regular national flights, and in addition the Parties organize and participate in specific joint CEPCO Flights. Sub-regional agreements between neighbouring countries are appreciated.

The information of available aircraft and flight hours of all Contracting Parties is available on [the HELCOM website](#). [Chapter 1. Information by the Contracting Parties](#) contains the contact details of responsible aerial surveillance authorities and contact points of joint aerial surveillance in the Baltic Sea. [Annex 8](#) includes the waypoints used in aerial surveillance.

¹⁴ Co-operation on surveillance is carried out in accordance with [Annex VII \(Regulations 1, 3, 4 and 10\) of the Helsinki Convention](#) and [HELCOM Recommendation 34E/4: Airborne Surveillance with Remote Sensing Equipment in the Baltic Sea Area](#).

¹⁵ Under the auspices of the HELCOM Response Group

6.1. FLIGHT TYPES

6.1.1. Regular National Flights

National flights are defined as flights where the extent and timetable are decided individually by each Contracting Party. National flights are recommended to take place within and outside the borders of the country in question. This is done to cover by individual and joint action the whole of the Baltic Sea area with regular and efficient airborne surveillance¹⁶.

The HELCOM Contracting Parties are recommended to coordinate surveillance activities which take place outside territorial waters. The results of such regular national surveillance are to be reported yearly to the HELCOM Response Group. This is done in accordance with the agreed HELCOM annual reporting format on illegal discharges observed during aerial and satellite surveillance.

6.1.2. CEPCO Flights

The aim of the CEPCO flights is a continuous flight activity within the responsibility zones of neighbouring Contracting Parties. According to a prefixed flight schedule, surveillance aircraft of the countries adjoining the CEPCO flights have to maintain a continuous surveillance (for 24 hours or more) and fly along the prefixed flight patterns. The chosen flight routes are where the likelihood of spills is higher than in other areas with sporadic traffic.

The chosen airport/air base should be located close to the respective area in order to shorten the approaching time of participating aircraft. The airport must ensure a day and night service for forthrunning landing and starting, and preferably ground power facility for stand-by.

Different endurances of aircraft should be taken into account when planning the route. The route length should be oriented on the lowest endurance time/endurance distance of the relevant aircraft. Route planning must exclude restricted areas for flight operations.

Diplomatic clearance for flights within neighbouring territorial waters must be sought for well in advance of the CEPCO operation. It is the responsibility of the participating Contracting Party to apply for diplomatic clearance for flights.

A communication scheme between the surveillance aircraft and patrol vessels must be disseminated to all participating Parties. This is to ensure a close co-operation between aerial detections and subsequent law enforcement, and/or prosecution measures, including sampling by patrol vessels.

CEPCO flights should be supported as far as possible with satellite images that cover the operation area. This is to provide indication of possible oil slicks.

¹⁶ [HELCOM Recommendation 34E/4: Airborne Surveillance with Remote Sensing Equipment in the Baltic Sea Area](#)

All the participating Parties must ensure a day and night service of their National Reporting Centres (R.C.). The Lead Country uses its R.C. during the CEPCO flight conduction as lead agency also for the coordination of unforeseeable events.

If a polluter has been caught red-handed, an urgent notice shall be sent to the R.C. in whose area the suspected pollution was detected.

Super CEPCO Flights

Super CEPCO flights are biannual CEPCO flights with duration of several days. Super CEPCOs are coordinated with the BONN Agreement in order to ensure that one Super CEPCO is organized every second year in either the Baltic Sea or the North Sea. This means flights are arranged once every four years under HELCOM and once every four years under the BONN Agreement. During the years when no Super CEPCOs are organized, the HELCOM Contracting Parties should arrange CEPCOs (North/South) or Mini CEPCOs.

CEPCO North and CEPCO South Flights

Every year, when there is no Super CEPCO in the Baltic Sea, a CEPCO North and a CEPCO South flight are carried out. They last for 24 hours or more and are participated of interested Contracting Parties located close to the selected surveillance area.

Mini CEPCO Flights

Mini CEPCO flights may be arranged by neighbouring Contracting Parties. A common area is continuously overflowed for 12 hours or more. To reduce the cost of the operation, the participating aircraft will use their normal national airports during the operation.

6.2. GUIDELINES FOR NATIONAL AERIAL SURVEILLANCE

The aim of the following provisions for surveillance flight planning is to give guidance and to implement the first part of [the HELCOM Recommendation 34E/4](#). The endeavour is to cover by individual or joint action the whole Baltic Sea with regular and efficient airborne surveillance. Priority at the flight planning must always be given to the detection and identification of polluters.

National surveillance is to be regarded as regular and efficient only, if:

- flights are carried out by duly trained crew
- flights fulfil the requirements of minimum flight frequency and equipment
- share of flights in darkness is carried out as specified later in this chapter.

The minimum requirements for regular surveillance flights relate e.g. to flight frequency and equipment.

Flight frequency

Twice a week: All coastal states should endeavour to fly - as a minimum - twice per week over regular traffic zones. This includes approaches to major sea ports as well as in regions with regular offshore activities.

Once a week: Other regions with sporadic traffic and fishing activities should be covered once per week.

Experienced observers/pilots shall take part in detections, classifications and quantification of observed pollution, as well as its frequencies and geographical distributions.

It is recognized that there might be some limitations for carrying out the surveillance flights due to weather conditions. All flights will be performed according to the national flight operational manuals.

Equipment

The following equipment can be considered as standard for surveillance aircraft operating in the Baltic Sea:

- video/photo cameras
- SLAR
- IR-UV
- EO/IR
- AIS receiver
- Maritime VHF with DSC
- satellite positioning system (GPS or similar).

The following equipment can be considered supplementary:

- microwave
- laser fluorosensor
- voice recording
- satellite telecommunication
- HF radio with DSC.

Flights without remote sensing equipment

The visual detection range under normal visibility conditions can be assumed with 20 km. Only under extremely good horizontal and vertical visibility can a detection range of 40 km be covered. However, a maximum cover range of 15 km on both sides of the flight patterns should be the basis for a minimum of flight hours for national flights. This is to ensure reliable and comparable observation conditions. GPS or similar is recommended.

Flights flown in darkness or poor visibility with remote sensing equipment

Flights in darkness or poor visibility have a limited possibility to visually identify offenders of MARPOL¹⁷, but standard modern equipment has overcome this limitation.

¹⁷ International Convention for the Prevention of Pollution from Ships (IMO)

Regular surveillance operations in darkness are recommended, but the share of flights flown in darkness (according to the aviation definition) is to be decided by the responsible authorities of the Contracting Parties based on operational assessment.

Satellite surveillance

Satellite surveillance is an important tool for supporting the aerial surveillance in the Baltic Sea. It is recommended that satellite detections are checked as soon as possible by aerial surveillance or other means available.

The HELCOM Informal Working Group on Aerial Surveillance (IWGAS) is responsible for defining the total operational needs for satellite images in the Baltic Sea and agrees on common practices.

6.3. REPORTING

The Contracting Parties will report on their entire annual surveillance activity during flights over their Exclusive Economic Zone (EEZ) in the reporting year. Observations obtained during flights outside a Contracting Party's responsibility zone, including CEPCOs, should be reported with a commonly agreed Standard Pollution Reporting Format to the country and organization responsible for the area. Contacts should be used in accordance with [Chapter 1. Information by the Contracting Parties](#) (or in accordance with special agreements e.g. CEPCOs). The country and organization responsible for the area should be the one that reports the data to HELCOM. An annual statistic is prepared by IWGAS.

7. CO-OPERATION IN OILED WILDLIFE RESPONSE

7.1. GENERAL PRINCIPLES

General principles of good practice with regards to oiled wildlife response include, *inter alia*, the following:

- Ensuring health and safety of responders and general public are always the first priority of response.
- Objectives and strategy are clearly defined at the start of the response by being an integrated part of pre-spill planning.
- National legislation applies at all times.
- Invited foreign response groups or personnel can only work under licence and supervision provided by the national authorities.
- Professional international responders (e.g. EUROWA¹⁸) should be compensated for their incurred time and expenses, if formally invited and deployed as a part of an authority led response.
- Criteria and procedures for euthanasia, rehabilitation and release are set by national authorities, with the support of oiled wildlife experts, and can only be applied under their supervision. Criteria and procedures are best defined in the oiled wildlife response plan.
- Activities always aim at meeting the highest standards of animal welfare. Euthanasia is used as a means of minimizing animal suffering in cases where rehabilitation does not apply or is limited in capacity. If rehabilitation is an option, it should only be conducted if adequate resources can be provided. The rehabilitation must aim to minimise suffering during care and maximise post-release survival of treated animals.
- It is clearly defined how the possible contributions of volunteers (self-mobilising citizens) and volunteer groups (expert/non-expert NGOs) will be integrated into the response activity. It is also defined how these contributions will be coordinated and controlled.

¹⁸ European Oiled Wildlife Response Assistance

7.2. POLLUTER PAYS

The Polluter Pays principle will be applied where possible, and claims should include the costs of a wildlife response. From the beginning, the wildlife response should be treated as an integrated part of the overall spill costs and claims structure. The probability that a claim is successful (i.e. paid by the Polluter) is enhanced if the wildlife response:

- is carried out in an organised and coordinated manner
- follows an agreed plan
- applies proven methodologies and internationally acknowledged protocols
- involves trained expertise and reliable parties who are informed about the recuperation of costs incurred
- follows a procedure to register and report reasonable wildlife costs from day 1 of the incident (e.g. timesheets, financial records, personnel assignments, travel and accommodation costs etc.).

7.3 WILDLIFE SCENARIOS AND COOPERATION

A spill of oil or other harmful substances in the Baltic marine environment has the potential to affect marine birds and mammals. Marine birds, in particular, could wash ashore in large numbers following an incident. The purpose of a fully integrated wildlife response strategy is to prevent and mitigate the effects of a pollution incident on animals, their habitats and populations. Such a strategy incorporates international objectives, allows the blending of national and international expert resources, and allows for cooperation on cross border aspects.

7.4 INTERNATIONAL OBJECTIVES OF A WILDLIFE RESPONSE

Wildlife response should serve the international objectives of species and habitat conservation and agreed international principles to deal professionally with animal welfare aspects.

Conservation

Decisions concerning wildlife response by one Contracting Party (CP) can strongly impact the nature conservation interests of another CP or the conservation objectives of the wider Convention. Species of conservation value (Red List species) will require priority attention but others will still need to be considered, especially if they are impacted in large numbers. A minimum requirement is that data are systematically gathered on the numbers of animals of every species that are impacted by a pollution incident. This requires a scientific lead and analysis to make sure the data and results are reliable, and to include number per species, sex,

adult-juveniles and additional biometric data that could connect them to a breeding colony. For certain species, an explicit effort to try to rescue and rehabilitate live animals may be required from a conservation perspective.

Animal welfare

A pollution incident may lead to live animals appearing on the shoreline suffering from the pollution. These animals cannot be left to the intentions of self-mobilising citizens or unexperienced NGOs as it requires a professional approach to deal effectively with the various and complex issues of animal welfare. This needs predefined objectives, well elaborated strategies in the field of rehabilitation and/or euthanasia and the guaranteed availability of key resources. Most important is i) operational lead from the authorities and ii) the involvement of pre-identified experts who can apply accepted science-based methodologies and recognised international standards and protocols for rehabilitation and/or euthanasia, and who should also be assigned to lead and manage these technical operations.

7.5 APPLICABLE TOOLS AND PRINCIPLES

Wildlife response via spill response measures

1. Proactive and reactive measures should be taken to prevent pollutants approaching sensitive habitats or large concentration of animals. Incident managers need to be fully aware of these environmental risks by having access to operational scientific data and/or scientists who can indicate where wildlife concentrations are located in relation of the oil as well as how behaviour and patterns may change over time. With this overall picture, managers will have the opportunity to prioritise the use of resources and reduce the number of animals that eventually can or will be polluted. They also have the opportunity to notify key authorities who in turn can consider the timely (or pro-active) mobilisation and deployment of resources that are needed for an on the shore wildlife response.

2. Due consideration should be given to the effects that certain response operations could have on (the behaviour) of wildlife present in the operational area, or on the durable quality of their habitats. The involvement of scientists with specific local or regional knowledge is important and may lead to a wiser application of measures that serve wildlife objectives without compromising the combat requirements.

An integrated operational wildlife cell

The lead authority of the wildlife response should set up an operational cell with a team of managers that can oversee all the strategic, tactical and operational aspects of the wildlife response. This cell must be fully integrated into the overall incident management to the effect that:

- The wildlife response is well funded and resourced, and can be made part of the Polluter Pays principle.

- Wildlife response decision-making becomes part of the overall incident response decision-making and information can be optimally shared between all components of the response to inform the decisions.
- The wildlife response cell can optimally deal with cross border issues, including international information sharing, optimising resources on both sides of a border, benefiting efficiency and cost effectiveness.
- Expertise and equipment can be resourced from abroad, using the general guidelines as described in Chapters 7.2-7.4.

Command structure for accommodating strike teams from abroad

The requesting Party shall provide a clear command structure for oiled wildlife response as an integrated part of the overall oil spill response command structure (see Figure 3). The Assisting Party (e.g. EUROWA, NGO, individual foreign experts) will be informed about this structure and given a clear role and responsibility as a part of that command system.

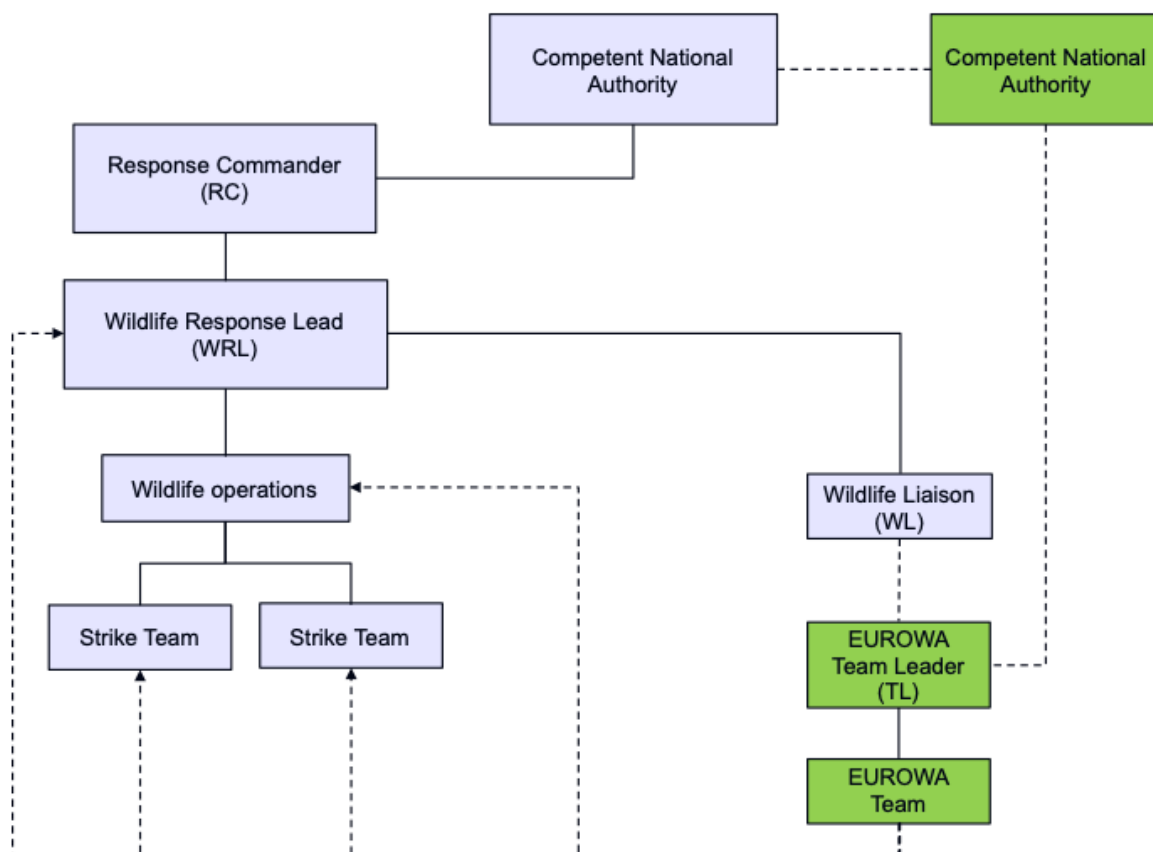

Figure 3: Command structure of the Requesting Party (purple) and command structure of the Assisting Party (green). A EUROWA Team has been taken as an example. Solid lines are management relationships. Dotted lines are communication lines; dotted arrows are technical assistance.

The invited contributions of experts from abroad often include the set up and running of a rehabilitation facility, scientific impact assessment, search and collection and/or management

coaching. Groups or individual experts can be integrated into the command structure accordingly.

The Assisting Party, when considered as an organised group or Network, is expected to have its own command structure, including a Strike Team Leader (TL) with controlling power over the mobilised international group. The TL will liaise directly with the Wildlife Liaison (WL) who facilitates the Strike Team on behalf of the Wildlife Response Lead (WRL). The Assisting Party will be asked to provide:

- names and affiliation of the experts in the proposed team
- internal command structure of the team
- expertise they can give
- their operational needs if integrated into the national response.

The Assisting Party will be kept informed at all times by the Wildlife Liaison (WL, c.f. Liaison Officer see Chapter 2). The WL has a direct link to the national command structure and is mandated to deal with the foreign experts. The Lead Country provides all means feasible to ease the work of the foreign experts.

Cross border information exchange and cooperation

Wildlife authorities leading the wildlife operational cells on both sides of a border should be enabled to exchange relevant information and make requests to each other that would make the overall response more effective, reduce overall costs of the response, and allow an optimised use of resources. This exchange could include, for example, the formal approval and generation of documentation for transport of captured oiled animals across the border, in the case that a higher quality of care can be provided on the other side of the border.

7.6 NATIONAL PREPAREDNESS

It is important that, as a matter of their national preparedness, all CPs have in place:

- A strategy and tactical plan with clear objectives and identified resources
- A leading wildlife authority that sets up an operational cell to manage the wildlife response
- Trained and exercised national resources including experts and equipment
- A wildlife contact point for mobilisation and accommodation of international responders

HELCOM Recommendation 31E/6 calls for the development of national wildlife response plans and preparedness systems by all CPs. The HELCOM Expert Working Group on Oiled Wildlife Response (EWG OWR) facilitates regional cooperation in support of the implementation of the Recommendation.

7.7 PREPAREDNESS BETWEEN CONTRACTING PARTIES

The HELCOM EWG OWR identifies mechanisms of international preparedness. This includes e.g.

- The identification of wildlife authorities in different parts of the Baltic Sea that could facilitate cross-border information exchange and cooperation
- Overview of stockpiles of wildlife response equipment
- Exchanges about the level of preparedness in different CPs, via the Self-Assessment Tool, and descriptions of this preparedness.

7.8 STRIKE TEAMS FOR WILDLIFE RESPONSE

Strike teams for wildlife response can be defined as operational groups that are deployed to carry out field operations or facility operations as follows:

- **Reconnaissance strike team.** Operational group that inspects parts of affected area (aerial surveillance) or coastline (by boat or vehicle) to monitor and identify wildlife threatened or affected. They report on numbers of observed animals and their location, degree of oiling, species, occurrences, required resources for capture.
- **Search and collection strike team.** Operational group that can take care of the search capture and collection of affected animals in a defined sector of the coast. The group will need resources such as vehicles, equipment, shelter.
- **Hazing/deterrence strike team.** Operational group that attempts scaring away animals from coastal or marine areas that are affected by oil.
- **Impact Assessment strike team.** Operational group that oversees the collection of all dead animals, the documentation, sampling and storage, analysis via necropsy and biometry, and reporting.
- **Field stabilisation strike team.** Operational group that sets up and operates a field stabilisation centre (when required), where affected animals can be stabilised (48 h minimum) before transported to a full rehabilitation centre.
- **Rehabilitation strike team.** Operational group that sets up and operates a full rehabilitation centre where affected animals can be stabilised, washed, rehabilitated and from where they can be released to the wild with a scientific tag.

Only one source of personnel exists in Europe from where all types of international strike teams can be invited: the EUROWA Network

7.9 ASSISTANCE FROM THE EUROWA NETWORK

The EUROWA network can be activated via a notification to Sea Alarm (BE), which can be done directly, or via CECIS. The EUROWA Standard Operating Procedure will be operated which can lead to the mobilisation of an international response team of qualified experts. The Team is headed by a Team Leader (TL) who acts as the point of contact for the Wildlife Liaison (WL) of the Requesting Party. The EUROWA Team also has a dedicated Technical Director (TD) who takes care of the technical leadership and the deployment of Team Members, when arrived in-country.

The EUROWA network can provide assistance via various fields of expertise:

- Wildlife response management: overall management, field ops management, facility ops management
- Field activities: expert personnel for field strike teams
- Facility operations: expert personnel for rehabilitation facilities and veterinary care

Qualified EUROWA experts work according to established international guidelines as published by EUROWA and IPIECA (see References).

7.10 TRAINING AND EXERCISES

The EWG OWR has developed guidelines¹⁹ for training of wildlife responders (using EUROWA qualifications) and the design of exercises (following the HELCOM classification, see chapter 8, and box below).

Training according to the EUROWA qualifications will enable the development of wildlife expertise in different countries, while these trained resources can provide mutual assistance across borders using a common set of wildlife protocols and standards. Such mutual assistance can be facilitated via the EUROWA SOP, by which a coordinated international Team is formed (see section 9), or directly via bilateral exchange between two CP's.

Guidelines for the design and development of wildlife exercises follow the HELCOM categories and nomenclature as described in Chapter 8 of the Manual.

BALEX ALPHA-W (wildlife table top exercise)

A table top wildlife exercise in which a wildlife scenario is introduced to a group of participants who represent two or more CPs. The ALPHA-W can be integrated into another ALPHA table top or even a DELTA or DELTA-W exercise.

BALEX BRAVO-W (wildlife alarm exercise)

Currently the EUROWA Module could be tested as part of a BALEX BRAVO exercise, by sending a request via CECIS. In the future, when CP's would have their own internationally qualified response personnel, teams or equipment, BRAVO-W exercises could include the request for these systems

¹⁹ Published on the EWG OWR workspace

via bilateral or multilateral communications. In terms of equipment, for instance the mobilisation of the Finnish Bird Cleaning Unit (BCU) could be requested for.

BALEX CHARLIE-W (wildlife equipment exercise)

For wildlife this could include an exercise in which a full equipment solution could be mobilised for a demonstration, or used for training, for instance Finnish Bird Cleaning Unit.

BALEX DELTA-W (wildlife operational exercise)

A host country CP could design and plan for a wildlife exercise in which field activities or facility activities are simulated by (teams of) trained personnel. The interaction between personnel from different CPs will be useful to explore common standards for animal handling, management, documentation and communication.

BOX: Description of exercises that can be designed and organised in the field of wildlife response (source: EWG OWR)

7.11 REFERENCES

HELCOM Contracting Parties jointly recognise and agree on the use of the following guidelines and documents to be applied in oiled wildlife preparedness and response:

- [*Wildlife Response Preparedness \(IPIECA\)*](#)
- [*Key Principles for the Protection, Care and Rehabilitation of Oiled Wildlife \(IPIECA\)*](#)
- [*Handbook on Oil Impact Assessment \(for seabirds\)*](#)
- [*Claims Manual \(IOPC\)*](#)
- [*EUROWA documentation and manuals*](#)

8. FRAMEWORK FOR EXERCISES

In accordance with the Helsinki Convention²⁰, the Contracting Parties shall regularly arrange joint exercises at sea and on shore. All HELCOM Response exercises should support the development of HELCOM cooperation on the response to marine pollution.

While recognizing that the training and exercising of specific capabilities is primarily a national responsibility, the focus of HELCOM Response exercises is to develop and test the cooperative aspects of HELCOM Response operations, which may lead to revisions to HELCOM Response Manual or Recommendations. These cooperative exercise activities have proven to be vital in order to ensure rapid, coordinated and efficient response to marine pollution. Exercises also provide opportunities to exchange information on capabilities, capacities and methods as well as for networking.

Consequently, this framework for exercises is established in order to enable and promote a systematic, holistic and resource efficient approach towards all exercise activities within HELCOM Response. This chapter of the manual provides an overall picture of the exercise framework and helps establish its foundation. The HELCOM Response Exercise Plan (HREP) outlines the exercise projects to be conducted. The HREP is updated annually by HELCOM Response following the process outlined in Annex 11, *The HREP Process*. In this process exercise needs are identified and exercise aims and exercise project Lead Countries are proposed. A Practical Guide for HELCOM Response exercise projects describes and provides guidance in how to design, plan, conduct, and evaluate exercise projects. The Practical Guide is part of the HELCOM Response work programme, and regularly revised by HELCOM Response. A HELCOM Response exercise project should have a clearly defined aim and clearly defined objectives²¹. Each year one Contracting Party is appointed Exercise Project Lead Country by HELCOM Response. A HELCOM Response Exercise Development and

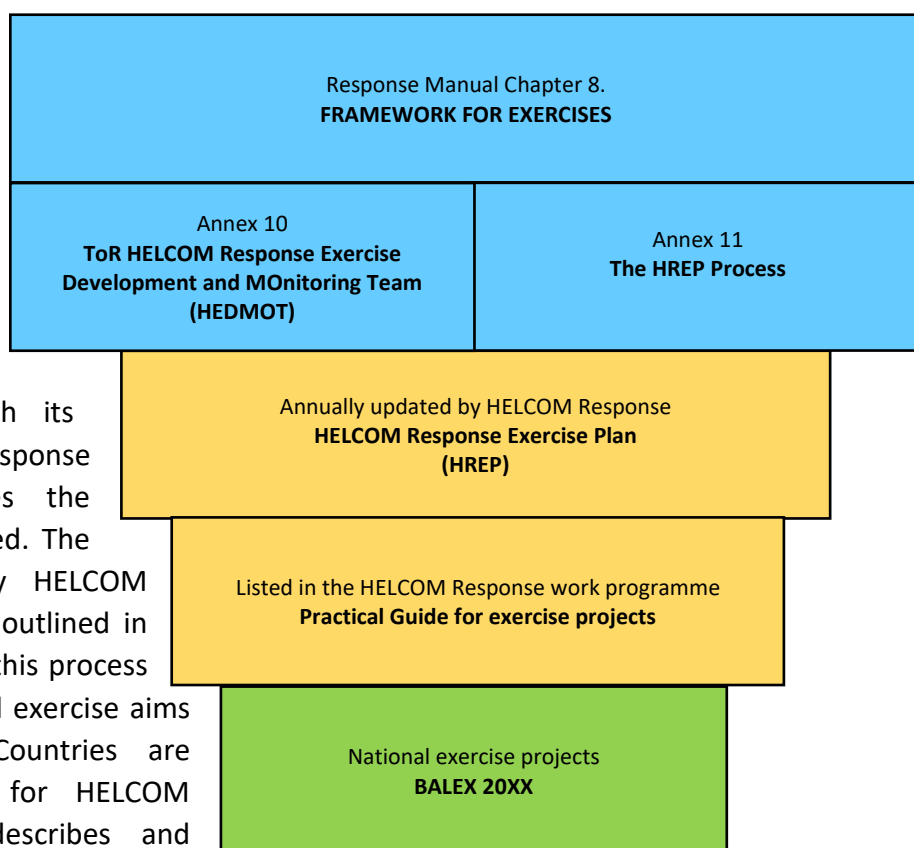

²⁰ [Annex VII \(Regulation 10\) of the Helsinki Convention.](#)

²¹ Take into consideration that every exercise project shall have only one aim defined in one paragraph and a number of objectives that together help fulfil the aim.

MOntoring Team (HEDMOT) is established to support a long-term approach to HELCOM Response exercises. The Terms of Reference for HEDMOT are found in Annex 10.

The framework, as illustrated in the above figure, consists of three documents, the Manual, including its Annexes, the HREP, and the Practical Guide. Together these documents describe the HELCOM Response exercise activities. In order to fulfil the objective of the framework, a process for the definition of exercise projects is outlined in Annex 11, the HREP Process.

As a basis for the HREP process, the HEDMOT²² should present a needs analysis taking into account the gaps identified and capabilities that are to be focused on. This list will be used to formulate proposals for exercise aims, which, when adopted and included into the HREP, future Exercise Project Lead Countries may choose from.

Based on the chosen aim, the Exercise Project Lead Country presents an exercise project directive to HELCOM Response, outlining the direction and scope of the exercise project with details such as timeframe, objectives, type(s) of exercise(s) to be conducted and possible location(s) or venue(s). HELCOM Response provides input and adopts the project directive.

Following the adoption of the exercise project directive, the Lead Country establishes the project organisation and conducts the planned exercise activities within the project. Based on the lessons identified in the exercise evaluation, an improvement plan will be developed in accordance with the HREP process (Annex 11). HEDMOT is also responsible to monitor and evaluate exercises.

As a general rule, all contact addressees of HELCOM Response should be invited to participate in the exercises via the HELCOM secretariat. In those cases where this is not possible, all should be invited to take part in the observer program when arranged in conjunction with an exercise.

All HELCOM Response exercises shall use the operational procedures and methods specified in this manual. The only exceptions are exercises with a specific objective to develop or test suggestions for new or revised procedures and methods.

²² Take into account that the HEDMOT composition of Contracting Parties will change on a yearly basis.

9. FINANCIAL ASPECTS

9.1. PRINCIPLES OF COSTS OF ASSISTANCE

[The Regulation 9 of Annex VII of the Helsinki Convention](#)²³ defines the principles for reimbursement of cost of assistance as follows:

- a) If the action was taken by one Contracting Party at the express request of another Contracting Party, the requesting Party shall reimburse to the assisting Party the costs of the action of the assisting Party. If the request is cancelled, the requesting Party shall bear the costs already incurred or committed by the assisting Party.
- b) If the action was taken by a Contracting Party on its own initiative, this Party shall bear the costs of its action.
- c) The principles laid down above in subparagraphs a) and b) shall apply unless the Parties concerned otherwise agree in any individual case.

The costs of the action taken by a Contracting Party at the request of another Party shall be fairly calculated according to the law and current practice of the assisting Party concerning the reimbursement of such costs.

The provisions of the Regulation 9 shall not be interpreted as in any way prejudicing the rights of the Contracting Parties to recover from third parties the costs of actions taken²⁴. These response actions deal with other applicable provisions and rules of international law and national or supra-national regulations.

The Governments of the Contracting Parties should use the following guidelines, when deciding the financial implications between the requesting and the assisting Party/Parties:

- a) The calculation must be based on *cost price*. That is a fundamental principle for the *calculation of costs* which should be paid by the requesting Party to the assisting Party/Parties.
- b) An assisting Party shall at any time be prepared to give the requesting Party a *preliminary estimation of the costs* for the assistance.

9.2. CALCULATION OF COSTS OF ASSISTANCE

²³ Regulation 9: Reimbursement of Cost of Assistance

²⁴ In order to assist EU Member States, EMSA has developed [EU States Claims Management Guidelines - Claims Arising Due to Maritime Pollution Incidents](#).

The calculation of costs of assistance rendered is normally based on national regulations of the assisting Party²⁵. If specific national regulations do not exist, the following principles should be used when calculating the costs of assistance.

9.2.1. Costs of a Ship

The cost of a ship is based on the hours the ship has been used. The hours are calculated from departure base port to arrival base port. For a possible standby in other ports during operation capital costs are charged, but normally no maintenance costs.

The following formula can be used in calculating hourly rate (cost per hour). The costs of the year of an incident are not known before the end of the year and they may include some rare main investments or repairs. Therefore, the ship's actual fair rate may be the previous year's rate or an average of the ship's rates for the last three years, converted to the concerned year's price index.

Cost per hour = $\frac{a + b + c}{24 \times \text{days}}$ where:

"a" = Yearly maintenance and service cost. Expenses for running the ship, like year docking, overhauling engines and hull, paintings, renewing worn parts and other normal maintenance and service. That does not include expenses of fuel and other oil products nor expenses of the ship's crew.

"b + c" = Capital costs are the sum of the write-off capital annually and the remaining capital's annual interest. Either the write-off in the balance or the write-off remaining values annually methods can be used. Remaining values method gives higher costs at first and lower later and is more difficult to calculate than the write-off in the balance method. In the following the write-off in the balance method is presented.

"b" = Write-off in the balance. The lifetime of the vessel depends generally on its size. For boats under 18 meters it is about 15 years, for ships under 30 meters 20 years and for bigger ones 25 years. Therefore "b" is equal to one/lifetime of the day's price of the ship. Today's price of the vessel is calculated from its delivery costs, like building or purchasing costs, and technical investments to the ship after its delivery. Everything is converted to the concerned year's price index. Possible scrap value at the end of the use time (for instance 5 %) may also be considered.

²⁵ Regarding hire rates of EMSA' assets, specific pre-defined costs apply as per EMSA's Incident Response Contracts. These hire rates have been agreed with the International Group of P&I Clubs and the IOPC Funds in a MoU.

"c" = Interest of capital. The amount of the capital the vessel presents is its remaining value. In the write-off in the balance method the today-price of the vessel has to be reduced with $(100/\text{lifetime}) \%$ per year. The result has to be multiplied with the appropriate government's rate of interest (6 - 9 %).

"24 x days"= Amount of days when the ship will be ready for operations. For getting the cost per hour the result has to be divided with 24.

9.2.2. Other Costs

Costs of fuel, lubricants and hydraulics

Consumption of oil products is calculated by gauges on board the ships. Consumption of oil products of other equipment such as aircraft, power pack, vehicles etc. will be reimbursed based on values on invoices of retailer. The requesting Party can also pay directly to the retailer (such as a fuelling company) the costs of oil products needed to run the equipment.

Labour costs: salaries and fees concerning ship crews and duty officers

Only all real labour expenses are charged. Besides normal wages and sea service compensations, also the overtime working compensations which shall be verified by proper record keeping, are payable. Working on a voluntary basis in very hard tasks may be rewarded and such rewards can be claimed too, if justified and properly recorded.

To find out the total expenses caused by state employees to the state, one must add some percentages to salaries actually paid. That addition depends on legislation for employment and conditions of work and employment. They may include all other direct costs from employment. They are e.g. salary during annual leave, extra money paid during annual leave, salary during sick leave, a social insurance fee and costs of retirement allowance. Total percentage for that varies and may be up to 70 %. The salaries and fees are without any general overhead.

Labour costs include costs of response personnel, such as crews of vessels and other Strike Teams. To simplify calculations the salary and fee may be estimated on the basis of an average of the entire crew's salaries and fees. Labour costs of administrative personnel in duty for the incident may also be included, when properly recorded and justified. No other administration fee should be included.

Lost material, rent of special equipment, repairing, special cleaning etc.

The assisting Party is entitled to claim also other expenses like:

- lost material: value of redelivery
- rent of special equipment: wearing of it (for instance rent of oil booms 2 % of purchase price per day in real use or 1 % for a skimmer) or a rent calculated by another way
- repairing: full price if not fault by own neglect
- cleaning costs of equipment and vessels
- handling costs of recovered oil and oily wastes
- cost of the use of telecommunication etc.

10. OIL SAMPLING

Oil sampling can be carried out for operational reasons or source identification. Oil can be sampled from a spill e.g. to pre-check the applicability of cleaning methods. Beside those applications directly linked to response and clean-up operations, oil spill samples are also taken in a legal context for environmental forensic investigations. They aim at identifying the source of the oil spills. The information is used in legal procedures both in case of illegal discharges and accidental oil spills.

10.1. OIL SAMPLING

As in all environmental forensics, oil sampling is the key element to meaningful results. Legal sampling is the first crucial step in a chain of procedures that ultimately lead to data presented in a court case or data that is the base for long-term monitoring and compensation claims.

Since oil sampling happens “in the real world” under circumstances that are hard to control, it is the part of the process most prone to mistakes. Results derived from flawed samples are useless at best and misleading at worst. However, good sampling practice goes a long way in safeguarding reliable results.

Over the last decades, analytical procedures in pollution crime forensics have become increasingly sophisticated and are highly developed these days. However, for such analyzes to be successful, sampling in this context should be above any doubt about its legal credibility. Legal oil sampling is preservation of evidence and should be carried out in a way reflecting this fact.

The highly developed analytical techniques in place in environmental forensics today can only provide reliable data when they are derived from good quality samples. With new challenges like novel types of ship fuels it becomes increasingly important to monitor the applicability of sampling procedures.

In [Annex 12](#) of the Manual oil sampling is described in detail. The annex includes equipment and sampling techniques for different sampling situations and oil types, as well as aspects of sampling coordination, documentation and transport.

10.2. KEY ASPECTS OF OIL SAMPLING

Special requirements regarding legal sampling can differ between countries. However, some fundamental principles of good sampling practice are applicable throughout.

Good sampling coordination and planning

It is especially important to implement good sampling coordination nationally and internationally. Sampling procedures should be incorporated in national contingency plans and made as a part of the response training. Sampling coordination and planning should be organized in detail before an incident.

Oil sampling personnel should be specified beforehand, as well as the personnel who organizes the sampling on a higher level. Only when these responsibilities are precisely defined it is assured that oil sampling will be carried out in a timely fashion and that unbiased samples before cleaning operations are retrieved. Then it can also be ensured that the sampling pattern is representative and that the number of samples taken is sufficient. Producing additional work and high cost by parallel sampling from different organizations should be avoided.

Training of personnel

It is important to train sampling personnel in proper sampling techniques, as in oil sampling there is no going back. The dimension, location and chemical composition of the spill keep changing, so there is no possibility to repeat a faulty sampling campaign.

Use of standardized protocols

Standardized (international) protocols should be followed. By using them it is assured that the whole sampling personnel is working in a comparable manner applying the correct techniques. By using a standardized form of documentation it is ensured that documentation is complete, including the chain of custody.

Enough time for sampling

Since staff is often obliged to carry out different tasks during an incident, it is important to allot enough time for sampling among other obligations. Rushed sampling on the fly is no base for good-quality samples.

Annex 1. Terms Used in the Manual

Assisting Party A party that accepts a request for international assistance from a requesting Party that faces a major pollution emergency.

BALEX ALPHA – Table-top Exercise

An exercise that does not include any operational units. It can be in the form of a seminar discussion or of a role-play. BALEX ALPHA can be organized either online or with participants in the same location. It can be used to test or explore frameworks and strategies, existing as well as new ones. It can also be used to test and develop different types of cooperative processes, including staff processes and processes for the prioritization of resources. Furthermore, TTX can be used as pre-exercises to operational exercises.

BALEX BRAVO – Alarm Exercise

An exercise that tests the ability of the Contracting Parties to alarm, request support, and offer support as well as the technology and procedures supporting these actions. In its simplest form it is a communications test, measuring response times, but in most cases it is beneficial to also include the national processes, such as the identification of available resources. A BALEX BRAVO should always be included in the yearly exercise project.

BALEX CHARLIE – Functional Exercise

An exercise focus on one function, or a few functions, for example sampling or logistics. They can be drill exercises (repeating the same actions or procedures until achieving the desired training effects) or exploratory exercises where for instance new procedures within a function are examined. Functional exercises can also be used to test the capabilities of a specific function.

BALEX DELTA – Operational Exercise

An operational exercise (or full-scale exercise) that involves operational units deployed in a realistic operational environment and often supporting functions such as staffs and logistics. The focus of large-scale operational exercises is often cooperative aspects, for instance the cooperation between operational units

from different Contracting Parties. BALEX DELTA should primarily be used to test the overall system or to train and develop the multinational and cross-organizational cooperation in an operational setting.

**CECIS Marine
Pollution
(CECIS MP)**

The Common Emergency Communication and Information System for Marine Pollution is a web-based alert and notification application to facilitate emergency communication between EU Member States, other participating states, EMSA and ERCC. Within the Helsinki Convention the CECIS MP can be used for sending POLINF and POLFAC messages.

Combined Exercises

Exercises that integrate operations on the shore and at sea. A truly combined exercise requires a common planning process, common objectives, and that the resources at sea and on the shore carries out coordinated operations during the exercise.

Contracting Party

Contracting Parties of HELCOM are Denmark, Estonia, the European Union, Finland, Germany, Latvia, Lithuania, Poland, Russia and Sweden.

Core Planning Team (CPT) The CPT is formed by the Exercise Project Lead Country and its partners, and led by the Exercise Project Lead Country. Although an inclusive planning process will involve also other participants, the CPT is responsible for preparing the exercise project's planning activities as well as to continue developing the exercise in between meetings.

EEZ

The Exclusive Economic Zone is a sea zone over which a country has special rights regarding the exploration and use of marine resources. In the Baltic Sea area the EEZ defines the pollution response responsibility zone.

EMSA

The European Maritime Safety Agency is an EU agency charged with e.g. reducing the risk of maritime accidents and marine pollution by helping to enforce the pertinent EU legislation. EMSA can offer response equipment, satellite monitoring and expertise on oil and chemical response for marine pollution preparedness and response.

ERCC

The Emergency Response Coordination Centre of the European Commission is the heart of the EU Civil Protection Mechanism and

coordinates the delivery of assistance to disaster-stricken countries.

Exercise Host Nation The Exercise Host Nation is responsible to the Lead Country for the planning and direction of a specific exercise within the exercise project.

Exercise Project Lead Country

A Contracting Party is appointed Exercise Project Lead Country for a specific BALEX project, normally three to four years in advance. The Lead Country is responsible for the planning and implementation of the exercise project, including any pre- and post-exercises or training activities. Contracting Parties working with the Lead Country can act as Host Nation for a specific exercise or other activity within the framework of the exercise project.

HELCOM Exercise Development and Monitoring Team (HEDMOT)

HEDMOT is established to support a long-term approach to HELCOM Response exercises. The role of HEDMOT is both to formulate proposals for exercise aims that corresponds to identified needs and to monitor and evaluate ongoing exercise projects. Furthermore, it should identify development needs, draft an implementation plan for identified lessons, and, when necessary, propose updates of the Manual, Practical Guide and the HREP. The team consists of representatives from four Contracting Parties, on a rotational basis.

HELCOM Response Exercise Plan (HREP)

A plan outlining the HELCOM exercise projects to be conducted. It is updated annually by HELCOM Response according to the HREP process (Annex 11)

HELCOM Response Exercise Project

The Contracting Parties shall carry out a HELCOM Response exercise project each year. An exercise project may include several different exercises, as well as other types of activities. If the design and planning phases are included, an exercise project may last for 18 to 24 months. The exercise projects are named BALEX followed by the year (“BALEX 2027”, “BALEX 2028”). Every exercise project should include activities regarding response operations both on the shore and at sea.

HELCOM Response

The group works e.g. to ensure swift national and international

Working Group	response to maritime pollution incidents in the Baltic Sea. The group is in charge of updating the HELCOM Response Manual.
HNS	Hazardous and noxious substances
Joint Exercise	An exercise with two or more Contracting Parties participating.
Joint Rescue Coordination Centre	The JRCC is a special type of a rescue coordination centre that is operated by personnel from multiple military services and/or civilian services.
Maritime Assistance Service	According to IMO costal states are obliged to establish a function for MAS to handle events on ships that are in difficulty and environmental harm is imminent or has already occurred.
MRCC	Maritime Rescue Coordination Centre
National Contact Point	The National Contact Point (NCP) is responsible for the receipt and transmission of oil pollution reports. In the Baltic Sea countries the NCP is either MRCC or JRCC.
National Contingency Plan	A country's national action plan for responding to oil spills and hazardous substance releases. It contains information on national response capability and overall coordination among the responders.
POLREP	A standard marine pollution report format that has been defined in the International Maritime Organization's Manual on Oil Pollution: Contingency planning. Within the Helsinki Convention the POLREP messages can be sent via e-mail or by using the SafeSeaNet and CECIS MP softwares.
Requesting Party	A party that issues a request for international assistance when facing a major pollution emergency that requires external resources.
Rescue Coordination Centre	According to the definition of the International Convention on Maritime Search and Rescue (SAR) the RCC is responsible for promoting efficient search and rescue services. RCC coordinates the conduct of search and rescue operations within a search and rescue region.

SafeSeaNet

SSN is a vessel traffic monitoring and information system, established in order to enhance maritime safety and marine environment protection. It is a network for maritime data exchange, linking together maritime authorities from across Europe. It enables EU Member States, Norway and Iceland to provide and receive information on ships and hazardous cargoes. Within the Helsinki Convention the SSN can be used for sending POLWARN messages.

Annex 2.

National Response Structure of the Contracting Parties and the Role of the EU in Marine Pollution Response

DENMARK

The Competent National Authority for the state maritime environmental surveillance, enforcement and the state maritime pollution control at sea is delegated from the Ministry of Environment and Food to the Ministry of Defence.

Defence Command Denmark is the responsible authority for the state maritime environmental surveillance and enforcement and the state maritime pollution control at sea. It is also responsible for policies concerning maritime and aerial oil response operations.

The Ministry of Environment and Food is the Competent National Authority for the state environmental surveillance, enforcement and the state pollution control on the shore. Responsibility for shoreline response lies with the individual afflicted municipal boards. The Danish Emergency Management Agency (DEMA) can support the municipalities with shoreline clean-up operations.

Danish (Ministry of Defence) Acquisition and Logistic Organisation (DALO) is responsible for maintaining the response equipment and ships used by Defence Command Denmark and the equipment used by DEMA.

Defence Command Denmark is responsible for aerial surveillance of marine pollution.

The National Contact Point for requesting and providing assistance is the Maritime Assistance Service within Defence Command Denmark, National Maritime Operations Centre (NMOC).

ESTONIA

The Ministry of the Interior is the Competent National Authority for marine pollution response at sea and on the shore. The Estonian Police and Border Guard is responsible for oil pollution response at Estonian Exclusive Economic Zone (EEZ), territorial and internal waters. On the shore the Rescue Board is responsible for oil pollution response.

Oil recovery equipment and vessels are owned by the Estonian Police and Border Guard and Estonian Maritime Administration. The Rescue Board has oil recovery equipment for the protection of the shore.

The responsible authority for oiled wildlife response is the Environmental Board. Estonian Fund for Nature (an NGO) has also a role in oiled wildlife response.

Police and Border Guard is responsible for aerial surveillance of marine pollution.

National Contact Point for requesting and providing assistance is JRCC Tallinn.

FINLAND

The Ministry of the Interior is the Competent National Authority for marine pollution response. The Finnish Border Guard is responsible for oil and chemical pollution response at open sea. On coastal waters as well as on the shore the rescue service districts have the responsibility.

The governmental response equipment depots are maintained by the Finnish Border Guard. The rescue service districts have their own depots. Oil recovery vessels are owned by the Finnish Border Guard, Finnish Navy and private contractors. Rescue service districts have oil recovery boats.

For oiled wildlife response the legislation does not define the responsible authority, but in practice this task is carried out by the Finnish Environment Institute.

Finnish Border Guard is responsible for aerial surveillance of marine pollution.

National Contact Point for requesting and providing assistance is MRCC Turku.

GERMANY

The Central Command for Maritime Emergencies Germany (CCME) is the Competent National Authority for marine pollution response at sea, in the coastal waters and on the shoreline. Responsibility also extends to emergency towing, firefighting and injuries at sea.

The CCME is a joint institution of the German Federal Government and the Federal Coastal States. It was established to set up and carry out a mutual maritime emergency management in the North Sea and in the Baltic Sea. It is based in Cuxhaven (Northwest Germany).

The CCME consists of five different sections:

- Maritime Emergencies Reporting and Assessment Centre (MERAC), National Contact Point
- Marine Pollution Control / High Sea and Salvage Section
- Marine Pollution Control / Coastal Section
- Fire Fighting, Rescue and Medical Response Section
- Public Relations Section

During daily work routine the five sections form a "Competence Center" which deals with all questions related to maritime emergencies. In case of a complex emergency situation, the staff is being alerted and called for to coordinate immediate action of all necessary forces under the auspices of the Federal Government and the Coastal States. Personnel from the CCME forms this "Central Casualty Command", which is organized in four units. The head of the CCME takes the captaincy of the staff. The section heads are supposed to take over the most prominent tasks of the staff units.

These arrangements under a centralized command structure allow a rapid and comprehensive control of all necessary operations in major maritime emergencies. The CCME hereby utilizes personnel, equipment and know-how of all authorities and institutions of the federal government, the coastal states and private organizations responsible for the sea and the coastal area.

The Search and Rescue Service (SAR), including the Maritime Rescue Coordination Center (MRCC), is carried out in Germany by a private organization, the "Deutsche Gesellschaft zur Rettung Schiffbrüchiger" (DGzRS).

LATVIA

Responsibilities on oil spill response in Latvia are divided between different ministries and institutions. Responsible authorities are defined by the National Oil and Chemical Spill Contingency Plan (NOCSCP, for response at sea) and National Civil Protection Plan (for response on the shore).

The main responsible ministries are Ministry of Defence, Ministry of the Interior and Ministry of Environmental Protection and Regional Development. The Ministry of Defence is the main ministry responsible for oil spill response at sea and the Ministry of the Interior is the main ministry in charge of oil spill response on the shore. The Ministry of Environmental Protection and Regional Development is responsible for environmental and municipal aspects in oil spill response.

The main responsible authorities are Latvian Navy, State Boarder Guard, State Fire and Rescue Service, State Environmental Service and municipalities. The Latvian Navy is under the Ministry of Defence and is the main responsible authority for response at sea and participating in response operations on the shore. The State Boarder Guard is under the Ministry of the Interior and is participating in response at sea. The State Fire and Rescue Service is under the Ministry of the Interior and is the main response authority on the shore.

The State Environmental Service is under the Ministry of Environmental Protection and Regional Development and is the responsible authority for coordinating the implementation of the NOCSCP. It also coordinates oiled wildlife response and pollution investigation, as well as gives advice on ecological issues. Municipalities participate in response on the shore in their area of responsibility.

Responsible authority for aerial surveillance is the Latvian Navy – MRCC Riga.

LITHUANIA

The main national document for pollution response is the Contingency Plan for Oil Spill Incidents at Sea. The main responsible authorities for oil spill contingency operations in Lithuanian area of responsibility defined by this plan are MRCC, Lithuanian NAVY, State Border Guard Service, Klaipeda State Seaport Authority, Environmental Protection Department, municipalities.

The Lithuanian NAVY is under the Ministry of National Defence and is the main responsible authority for response at sea. MRCC, which is an integral part of Lithuanian NAVY, is designated as Operational Authority in relation to response actions and overall coordination to oil pollution incidents in the Lithuanian area of responsibility and is designated as national contact point related to oil pollution. MRCC is also responsible for organizing the aerial surveillance of marine pollution.

The State Border Guard Service is under the Ministry of the Interior and is participating in response operations in the Curonian Lagoon. Klaipeda State Seaport Authority is under the Ministry of the Transport and is participating in response operations in the port of Klaipeda. The Environmental Protection Department is responsible for investigating pollution incidents, provides recommendations for the MRCC on methods and measures for pollution incidents response and issues a permit for the use of dispersants

The municipalities are responsible for oil pollution clean-up activities in their respective coastal areas. Each municipality has its own Local Pollution Incident Response Contingency Plan.

POLAND

The Ministry of Maritime Economy and Inland Navigation is responsible for oil spill response at sea and co-responsible for oil spill response on the shore. The Ministry of the Interior and Administration is co-responsible for oil spill response on the shore.

The responsible authority for response at sea is the Maritime Search and Rescue Service, that has the operational responsibility in case of an oil spill and that is the National Contact Point in case of an oil spill at sea.

Maritime offices are in charge of maritime administration and have a legislative responsibility in oil spill response at sea and also co-responsibility in response on the shore. Poland has two separate Maritime Offices. One of them is in Gdynia (eastern part of the Polish coastline and Vistula Lagoon) and the other one is in Szczecin (western part of the Polish coastline and Szczecin Lagoon).

The responsible authorities for response on the shore are the State Fire Service (operational responsibility), regional state authorities (Pomerania and West Pomerania Voivodships) and local municipalities.

The responsible authority for oiled wildlife response is the Ministry of Environment (responsible for legislation and for the Oiled Wildlife Response Plan). Also different NGO's – most notable WWF Poland – has a role in oiled wildlife response.

Maritime Office in Gdynia is in charge of aerial surveillance.

RUSSIA

The Ministry of Transport of the Russian Federation and the Federal Agency for Maritime and River Transport are the Competent National Authorities responsible for preparedness and response to oil pollution in inland sea waters, the territorial sea and the Exclusive Economic Zone of the Russian Federation.

Marine Rescue Service is under jurisdiction of the Federal Agency for Maritime and River Transport. Marine Rescue Service is the responsible body for preparedness and response of oil and oil product spills in the Baltic sea through the Baltic and Kaliningrad branches.

The Ministry of the Russian Federation for Affairs for Civil Defence, Emergencies and Elimination of Consequences of Natural Disasters (EMERCOM of Russia) responds, manages,

coordinates and controls the protection of people and territories in emergency situations, including those caused by oil and oil product spills.

The Main departments of the EMERCOM of Russia are the responsible bodies authorized to solve the tasks of prevention and liquidation of emergency situations. In the Baltic Sea region the main department of the EMERCOM of Russia is in the North-Western Federal district²⁶.

Ministry of Natural Resources and Environment of the Russian Federation (Minprirody of Russia) is a federal body of executive power implementing functions on normative legal regulation, including in the sphere of protection of natural resources.

The Ministry of Natural Resources is responsible for the federal service for supervision of natural resources (Rosprirodnadzor, response to pollution of nature). It is also responsible for the federal service for hydrometeorology and environmental monitoring (Roshydromet, air pollution monitoring). In the Baltic sea region please contact the North-West Interregional Department of Rosprirodnadzor²⁷ and the North-West Department of Roshydromet²⁸.

SWEDEN

According to the Swedish regulation on protection against accidents, the Coast Guard is responsible for environmental rescue service at sea when oil or other harmful substances are released into the water or if there is an imminent danger of it.

In general response activities are conducted within Sweden's maritime territory and economic zone, as well as the lakes Vänern, Vättern and Mälaren. Outside Sweden's maritime territory the Coast Guard is responsible for environmental rescue services at sea according to the international agreements concluded by Sweden.

In the Coast Guard there is always an official in readiness (TiB). At the control centre there is always a Guard Command (VB) who can start an environmental rescue operation.

According to the law the municipality, whose rescue service is responsible for the preventive and restrictive measures, takes care of oil and chemical control on the shore and in the ports. Beach remediation operations are usually carried out by personnel other than the emergency services (e.g. other municipal resources, hired private remediation companies etc.)

For larger operations the county administrative board can take over the management of the operation. The contributions from participating municipalities are coordinated by the relevant county administrative board.

²⁶ e-mail: obsh_otdel_gu@mail.ru

²⁷ e-mail: rpn78@rpn.gov.ru

²⁸ e-mail: secretary@meteo.nw.ru

ROLE OF THE EU IN MARINE POLLUTION RESPONSE

The Union Civil Protection Mechanism (UCPM) covers both civil protection and marine pollution emergencies inside and outside the EU. The UCPM aims to strengthen the co-operation and coordination among the EU Member States and the Participating States²⁹. The purpose is to improve preventing, preparing for and responding to disasters.

If a request for assistance is made from a country affected by a marine pollution incident, the Emergency Response Coordination Centre (ERCC)³⁰ can facilitate mobilization and deployment of pollution response capacity and expertise from the EU Member States, Participating States and EMSA. More information on UCPM and its tools can be found on [the website of the European Commission](#).

EMSA's Pollution Response Services

The European Maritime Safety Agency (EMSA) offers four following main services in case of a pollution caused by a ship or an oil or gas offshore installation. The services are available upon request to EU Member States, coastal European Free Trade Association (EFTA) Contracting Parties, EU Candidate Countries and the European Commission. EMSA may also provide assistance to those third countries sharing a regional sea basin with the Union.

Emergency requests should be sent to the ERCC of the European Commission preferably through CECIS MP³¹ (Common Emergency Communication and Information System for Marine Pollution). Alternatively, the request can be sent to the ERCC by e-mail or fax.

EMSA's services are the following:

1. *Network of stand-by oil spill response vessels around Europe and several Equipment Assistance Services (EAS) composed of stockpiles of stand-alone oil spill response equipment and dispersant products*

Detailed procedures to request assistance of EMSA's contracted vessels or EAS are provided in the EMSA User Guides, which are distributed to coastal States through the members of the CTG MPPR (Consultative Technical Group for Marine Pollution

²⁹ Iceland, North Macedonia, Montenegro, Norway, Serbia and Turkey

³⁰ The ERCC is the operational hub of the Union Civil Protection Mechanism. The centre is operated by DG ECHO of the European Commission and is accessible 24/7.

³¹ CECIS MP is a secure web-based application to facilitate emergency communication among its users. It also contains a database of the Member States and EMSA operational response capabilities.

Preparedness and Response). These guides are also available on EMSA's password protected extranet, in the Pollution Response Services section.

Description of available vessels, their equipment and performance can be found in the CECIS Marine Pollution resources database and on [EMSA's website](#).

Detailed description of EMSA's Equipment Assistance Service (EAS) and the available equipment, including their performance, can be found in the CECIS Marine Pollution resources database and on [EMSA's website](#).

2. *CleanSeaNet (CSN), which is the European satellite-based oil spill detection and monitoring service*

The CSN offers assistance to the participating States in identifying and tracing oil pollution on the sea surface, in monitoring accidental pollution during emergencies and in contributing to the identification of polluters. Detailed information on the EMSA CSN service can be found on [EMSA's website](#).

3. *MAR-ICE Network (Marine Intervention in Chemical Emergencies Network) of chemical experts*

The MAR-ICE Network supports EU coastal states in responding to incidents involving hazardous and noxious substances (HNS) at sea. The Network provides expert advice and information on chemical substances for emergency response either remotely via email/phone (MAR ICE Level 1) or on-site at the Command Centre of the requesting Party (MAR ICE level 2), where an expert from the chemical industry may assist the authorities.

Information on activating the MAR-ICE Network has been distributed to the relevant authorities of the EU Member States and the coastal EFTA/EEA countries. More information on the MAR-ICE Network can be found on [EMSA's website](#).

4. *MAR-CIS Marine Chemical Information Sheets*

These datasheets of chemical substances contain relevant information for responding to marine spills of hazardous and noxious substances (HNS). The datasheets provide concise information on the substances' physical and chemical properties, handling procedures and emergency spill response procedures. They also contain maritime transport requirements for safe transport at sea.

EMSA can make available pollution response experts who can provide (on-site/office-based) operational and technical assistance for oil and HNS incidents. EMSA can also support the affected country by running a forecasting model upon request.

More information on EMSA Pollution Detection and Response Services can be found on [EMSA's website](#).

RELEVANT EU DOCUMENTS / GUIDELINES

- [*Addressing Illegal Discharges in the Marine Environment \(EMSA\)*](#)
- [*EU States Claims Management Guidelines – Claims Arising Due to Maritime Pollution Incidents \(EMSA\)*](#)
- [*Places of Refuge - EU Operational Guidelines*](#)
- [*Overview of National Dispersant Testing and Approval Policies in the EU \(EMSA\)*](#)
- [*Guidance and Best Practices \(EMSA\)*](#)

Annex 3. Bi- and Trilateral Agreements

The Contracting Parties are obliged, inter alia, to agree bilaterally or multilaterally on those regions of the Baltic Sea in which they will conduct aerial surveillance activities and take action for response and salvage activities³². As a principle the response regions should coincide with the boundaries of the Exclusive Economic Zones (EEZ), where applicable.

In addition to response at sea, also shoreline response should be included in sub-regional agreements between neighbouring Contracting Parties. Such agreements are aimed at ensuring fast and sharp reaction when a second and/or third tier or transboundary pollution accident has occurred.

1. VALID AGREEMENTS

The present situation of sub-regional agreements agreed is shown in the maps and the table in this annex.

It should be noted that in some sub-regions of the Baltic Sea also other agreements than the Helsinki Convention and the sub-regional agreements listed in this chapter are applied. An example is [the Copenhagen Agreement](#)³³ which in the Baltic is applied within the exclusive economic zones of Denmark, Sweden and Finland. Another example is [the Agreement on Cooperation on Marine Oil Pollution Preparedness and Response in the Arctic \(MOSPA\)](#)³⁴ applied in the Bothnian Bay north of 63° 30'00" N. EU regulations are applied in those Baltic States which are also EU Member States.

³² According to [Regulation 4 of Annex VII of the Helsinki Convention: Response Regions](#)

³³ Copenhagen Agreement between Denmark, Finland, Iceland, Norway and Sweden about Nordic Cooperation for the Marine Environment

³⁴ Arctic Agreement between Canada, Denmark, Finland, Iceland, Norway, Russia, Sweden and the United States

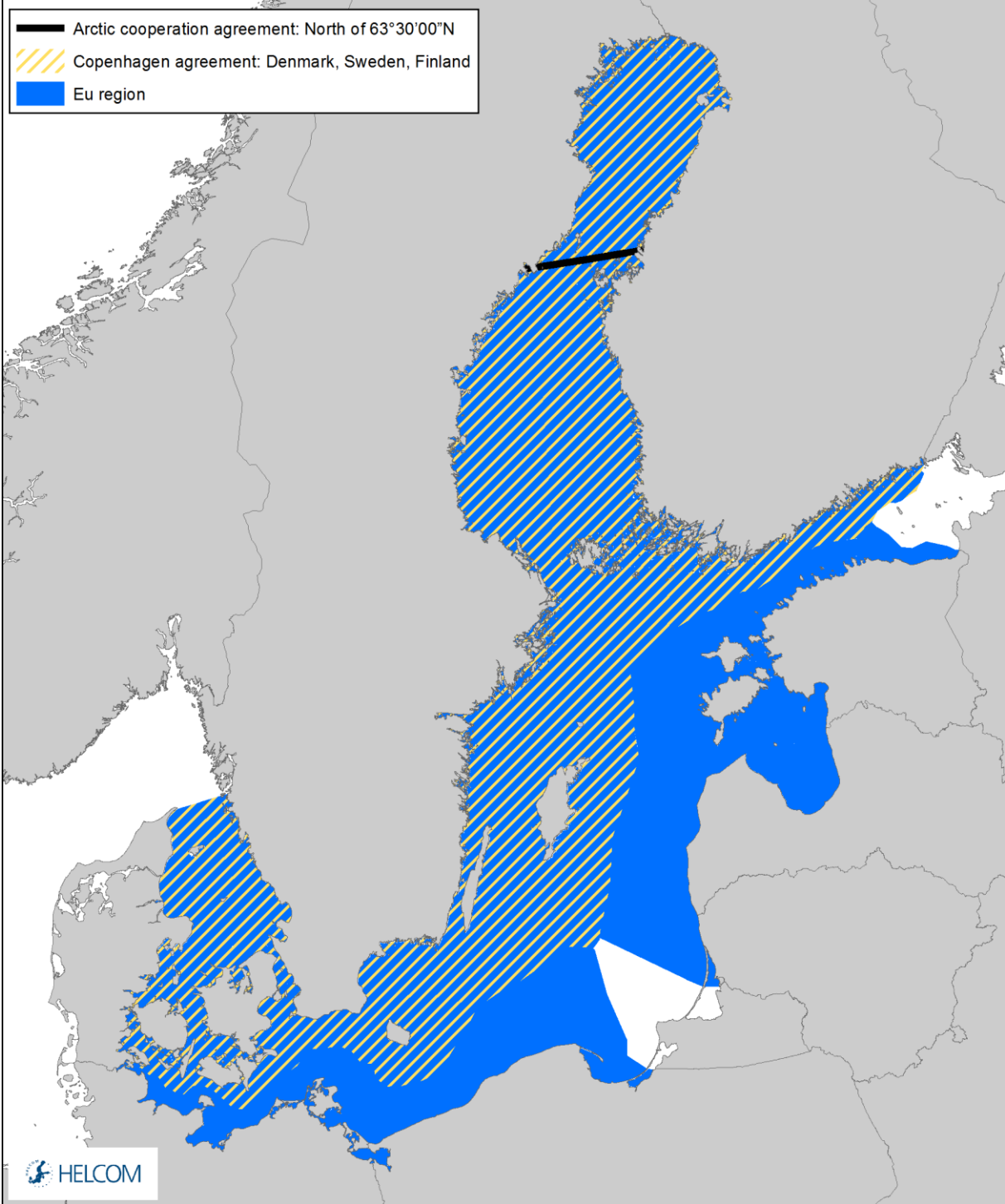

Map 1. Sub-regional agreements: MOSPA, Copenhagen Agreement and the EU Region.

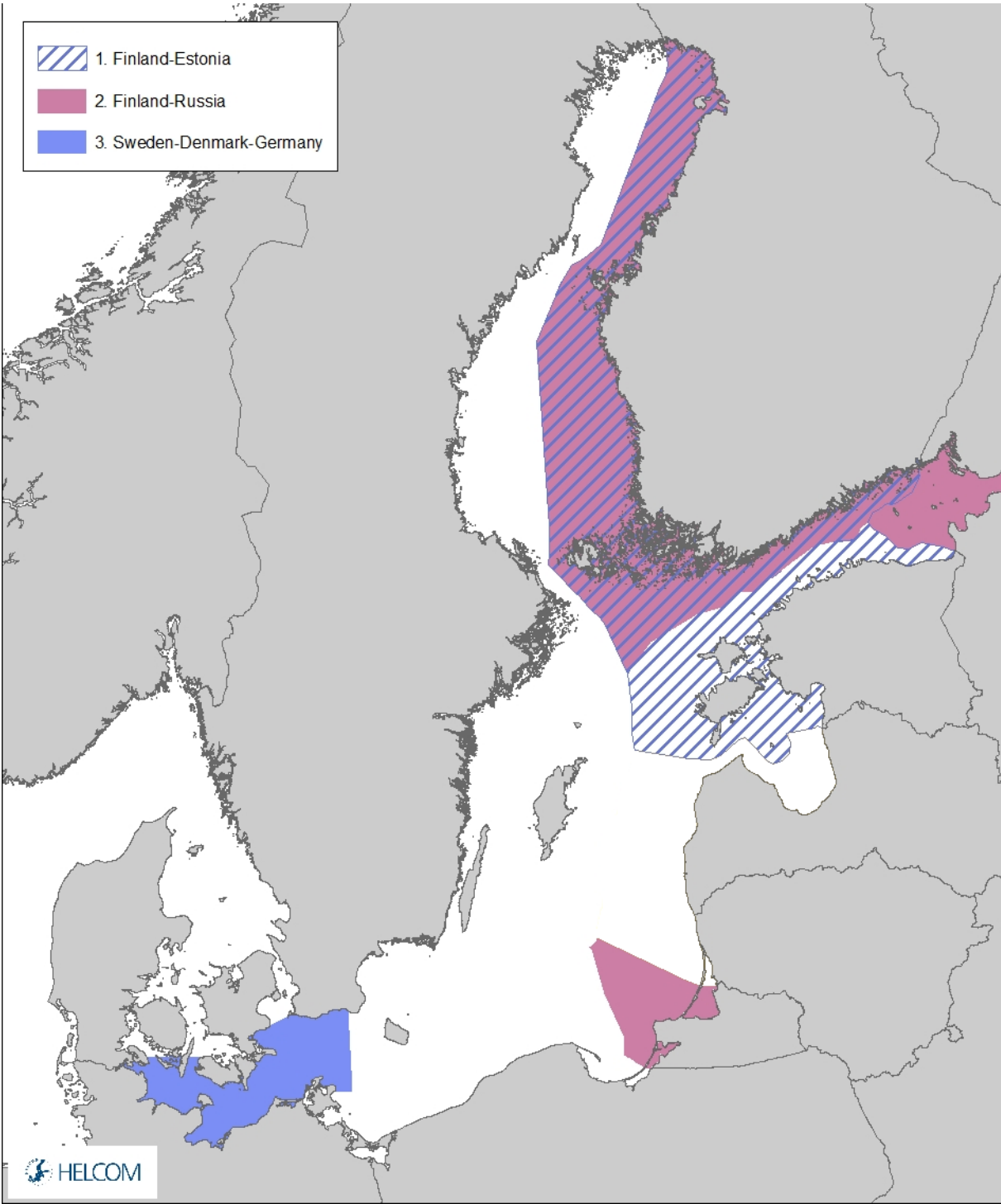

Map 2. Sub-regional agreements: Finland - Estonia, Finland - Russia and Sweden - Denmark - Germany.

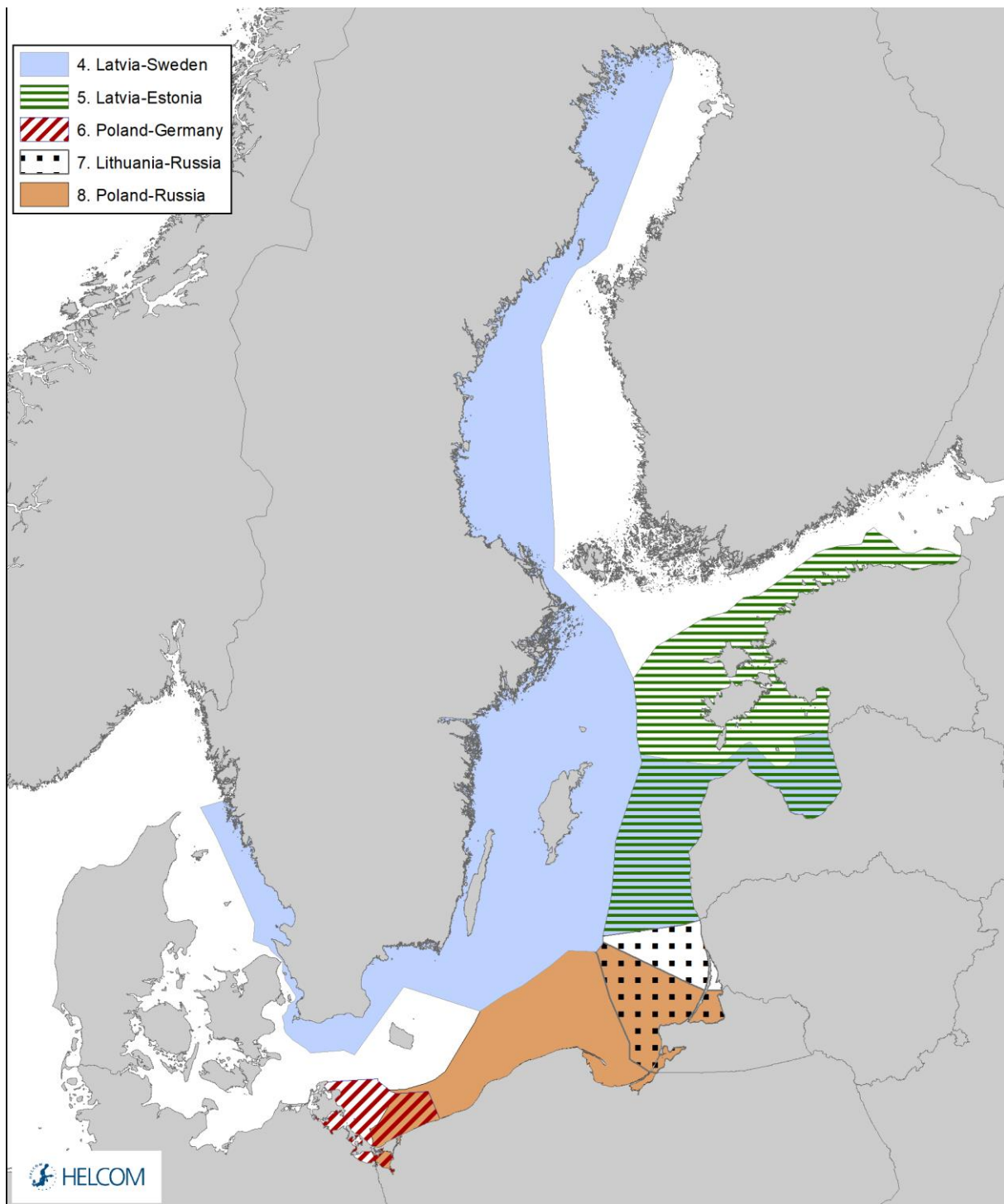

Map 3. Sub-regional agreements: Latvia - Sweden, Latvia - Estonia, Poland - Germany, Lithuania - Russia and Poland - Russia.

Table 1. Existing bi- and multilateral agreements on joint response operations and response plans in the response regions.

Countries	Sea area covered	Agreements and annexes Other related documents	Date	Subjects covered	Remarks
1. Estonia - Finland	The marine area under the jurisdiction of a Party, the boundary line of the economic zone or continental shelf (central line) determined on the basis of the international law	Agreement between the Government of the Republic of Estonia and the Government of the Republic of Finland on co-operation in combatting pollution in the marine environment	8.12.1993	Competent authorities, notification of pollution, assistance, management of operations, maintenance of units and equipment for rendering assistance, withdrawal of assistance for combatting pollution, simplification of access formalities, regular co-operation, compensation of costs, compensation of damage, plan of co-operation to combat pollution, settlement of disputes, relations with other international agreements	Operational agreement
		Memorandum with Finland concerning the patrol flights coordinated planning and executing; signed by heads of Finnish and Estonian Border Guard	26.8.2009		Operational
2. Finland - Russia	As defined in Agreement of 6 October 1983 between the Government of the Republic of Finland and the Government of the Union of Soviet Socialist Republics Agreement on the distribution of areas of responsibility according to the Convention on the protection of the marine environment of the Baltic Sea area	Agreement between the Government of the Republic of Finland and the Government of the Union of Soviet Socialist Republics on co-operation in combatting pollution of the Baltic Sea in accidents involving oil and other harmful substances	26.10.1989	Notification of an incident, request for assistance, obligation to provide assistance, operational command, maintenance of the assisting units and equipment, termination of combatting assistance, facilitation of access, exchange of information, scientific technological co-operation, joint exercises, reimbursement, harmful substances in packaged form, joint contingency plan, relation to other international agreements	Operational through joint contingency plan
		Finnish Environment Institute and the State Marine Pollution Control and Salvage of the Russian Federation regarding joint Finnish - Russian contingency plan for combatting pollution of the Baltic Sea	2003	Responsibility, definitions, relationship to the HELCOM Manual, notification of an incident, request for assistance, main principles and procedures, operational command structure and operational Command Centre, termination of assistance, post incident report, other co-operation	

Countries	Sea area covered	Agreements and annexes Other related documents	Date	Subjects covered	Remarks
3. Sweden - Denmark - Germany	Western Baltic Sea area: 1. Trilateral area (SWE-DE-GE) south from Sweden and west from Denmark (Arkona Basin) 2. Bilateral area (DE-GE) north from Germany (Kiel Bight, Mecklenburgh Bight) Map and coordinates in the agreement, Annex I	Joint Swedish-Danish-German response plan to maritime incidents involving oil and other harmful substances and co-operation in aerial surveillance (SWEDENGER) Annexes: - I Map of Response Regions in the Baltic Sea - II National Contact Points and Responsible Authorities - III Scheme of Communication - IV Special regulations "Aerial Surveillance" + Appendix I "Communication plan for aircraft during surveillance operation" - V Exercises - VI Ships and aircraft with diplomatic clearance in advance	2002	Information, activation, reporting, coordination, responsibility, diplomatic clearance, principles for response to pollution, aerial surveillance, financial matters, exercises	Operational
4. Latvia - Sweden	Territorial waters or economic zones of both Parties	Agreement Between the Government of the Republic of Latvia and the Government of the Kingdom of Sweden on Collaboration within the Field of Emergency Prevention, Preparedness and Response	2002	Mutual assistance, operational responsibility, border crossing, permission to entry, reimbursement of costs, liability, procedures and plans, competent authorities	Not operational
5. Latvia - Estonia	Territorial waters of economic zones of both Parties	Agreement Between the Government of the Republic of Latvia and the Government of the Republic of Estonia on Co-operation in the Combating of the Effects of Marine Pollution Incidents	16.1.2014	Competent authorities, notification of an incident, assistance, termination of assistance, reimbursement of costs of assistance, command of combating operations, facilitation of access, maintenance of assisting units and equipment	Operational
6. Poland - Germany	Pomeranian Bay	Operational Agreement (working level) on co-operation and response activities between the Public Services of the Republic of Poland and of the Federal Republic of Germany responsible for those activities concerning marine accidents and combating marine pollution by oil and other harmful substances	20.11.2001	Competent authorities, reference to the HELCOM Manual and procedures, list of available vessels and strike teams, crossing borders, right to begin response action, rules for costs reimbursement	Operational

Countries	Sea area covered	Agreements and annexes Other related documents	Date	Subjects covered	Remarks
7. Lithuania- Russia	Territorial waters or economic zones of both Parties	Bilateral agreement between Lithuania and Russia on joint actions to prevent pollution of the Baltic Sea by oil and hazardous substances	8.10.2009	Under the agreement a joint contingency plan developed	Operational through joint contingency plan
	Territorial waters or economic zones of both Parties	Contingency plan between Lithuania and Russia on co-operation in combating marine pollution of the Baltic Sea by oil and hazardous substances	25.04.2012	Competent authorities, responsibility, main principles and procedures, notification of an incident, request for assistance, operational command structure, exchange of information, termination of assistance, facilitation of access, post incident report, reimbursement of cost of assistance, joint exercises and meetings	Operational
8. Poland - Russia	Baltic Sea and the Vistula Lagoon, Territorial waters or economic zones of both Parties	Agreement between the Government of the Republic of Poland and the Government of Russian Federation on co-operation in combating marine pollution of the Baltic Sea and the Vistula Lagoon by oil or other harmful substances	6.12.2010	Competent authorities, reference to the HELCOM Manual and procedures, list of available vessels and strike teams, crossing borders, right to begin response action, rules for costs reimbursement	Operational

2. RESPONSE CO-OPERATION ZONES

The Contracting Parties have defined the response co-operation zones in the Baltic Sea to be used e.g. in interpreting and revising [HELCOM Recommendation 28E/12](#)³⁵ and [HELCOM Recommendation 31/1](#)³⁶. The indicative response co-operation zones of Western Baltic, Baltic Proper, Gulf of Finland and Gulf of Bothnia are included in Map 4.

³⁵ HELCOM Recommendation 28E/12: Strengthening of Sub-Regional Co-operation in Response Field

³⁶ HELCOM Recommendation 31/1: Development of National Ability to Respond to Spillages of Oil and Other Harmful Substances



Map 4. Indicative HELCOM response co-operation zones, EEZs and territorial waters.

Border between zone 1 and the North Sea

The line separating zone 1 from the North Sea is the Baltic Sea bounded by the parallel of the Skaw in the Skagerrak at 57° 44,43' N (Skaw-Gothenburg).

Border between zones 1 and 2

The line connecting the following points:

1	56° 16' 59,187''' N	15° 35' 4,844''' E
2	56° 8' 17,654''' N	15° 32' 37,481''' E
3	55° 36' 24,708''' N	15° 23' 47,190''' E
4	55° 21' 0,191''' N	16° 30' 18,029''' E
5	55° 13' 18,006''' N	16° 22' 12,003''' E
6	54° 42' 14,999''' N	15° 43' 2,999''' E
7	54° 37' 30,001''' N	15° 30' 0,000''' E
8	54° 35' 17,999''' N	15° 20' 0,000''' E
9	54° 32' 26,997''' N	14° 55' 5,999''' E
10	54° 32' 33,609''' N	14° 37' 22,422''' E
11	54° 32' 8,401''' N	14° 38' 8,171''' E
12	54° 31' 55,503''' N	14° 37' 37,949''' E
13	54° 29' 54,203''' N	14° 44' 52,665''' E
14	54° 9' 58,145''' N	14° 20' 50,735''' E
15	54° 7' 32,937''' N	14° 14' 14,868''' E
16	54° 7' 34,138''' N	14° 12' 5,044''' E
17	53° 59' 15,762''' N	14° 14' 31,521''' E
18	53° 51' 28,904''' N	14° 11' 49,254''' E
19	53° 36' 48,899''' N	14° 6' 46,308''' E

Borders between zones 2, 3 and 4

The line from the Northern Baltic trilateral EEZ junction point, estimated as 58° 51,51', 020° 29,42' to the coasts as follows:

- ESTONIA: a straight line from trijunction to Hiiumaa (Ristna light) (58° 56' 24" N, 022° 03' 19" E) and continuing to Estonian mainland (59° 0'7,053'', 23° 38'0,034'').
- FINLAND:

60° 01,83', 022° 47,00'			
59°	52,51',	022°	49,62'
59°	24,19',	022°	31,37'
59°	23,16',	022°	09,30'
59°	11,37',	021°	11,27'
58° 51,51', 020° 29,42'			
- SWEDEN: a line westbound to Landsort light house to latitude N 58 44,2 and longitude E 0 17.

Annex 4. EU Host Nation Support

The Contracting Parties can use the following EU Host Nation Support document as a checklist, when getting prepared for international requests of assistance regarding oil pollution incidents.

1. PREPAREDNESS		
<p>All emergency management actors should be identified and made aware of their responsibility in the different phases of the Host Nation Support process. All levels of emergency management authorities/actors should be aware of the Helsinki Convention, the Union Civil Protection Mechanism (UCPM) and the European Maritime Safety Agency (EMSA).</p> <p>General arrangements in sending, receiving and returning of equipment requested or offered are recommended to be adopted prior to any accident and could be usefully included in the national contingency plan. Thus, only the details of application would remain to be settled at the time of action.</p>		
Requesting Party	Assisting Party	Transit Nation
1.1. POLREP		
<ul style="list-style-type: none"> - Clarify procedures at national level regarding POLREP sending routines in accordance with Chapter 5. Pollution Report. - Include the use of POLREP into national contingency planning, courses, trainings and exercises. 	<ul style="list-style-type: none"> - Clarify procedures at national authority level regarding offering assistance (who makes the decision / places the offer in CECIS Marine Pollution). 	<ul style="list-style-type: none"> - Sort out if there is a need for a standardized form designed for the role of transit nation (border crossings, customs, Liaison Officer (LO), single contact point etc.).
1.2. Prepare arrangements for:		
<ul style="list-style-type: none"> - In-country transport - Accommodation (food, shelter and sanitary) - Medical support - Communication (terms, systems, limitations, frequencies etc.) - Fuel supply - Waive national transport regulations - Waive tariffs/taxes, tolls and other fees 	<ul style="list-style-type: none"> - Insurance - Self-sufficiency aspects - Interoperability of technical equipment - Access to transport for rapid deployment 	<ul style="list-style-type: none"> - Facilitate transport (clearance/notification to other national stakeholders). - Provide police or other relevant authority escorts. - Provide accommodation, medical support and fuel supply, if necessary. - Check whether it is possible to waive national transport regulations, tariffs/taxes, tolls and other fees.

1.3. Identification of entry points		
<ul style="list-style-type: none"> - Identify entry points to the country (land, air, in-land waters, sea) and make these points and their capacity available preferably in a catalogue or a map. - Make sure that all national stakeholders are informed of the national list of possible entry points for incoming assistance. 	<ul style="list-style-type: none"> - Procedure for acknowledging agreed entry point 	
1.4. Basic information		
<ul style="list-style-type: none"> - Prepare and keep Chapter 1. Information by the Contracting Parties updated. 		
1.5. Host nation support personnel		
<ul style="list-style-type: none"> - Identify, form and train national Host Nation Support teams/cells including Liaison Officers to meet/join the incoming teams. 		<ul style="list-style-type: none"> - In case of long duration transit, consider appointing a Liaison Officer as long as the assistance/team is still in transit.
1.6. Risk assessment		
<ul style="list-style-type: none"> - Analyze national risks and identify possible capacity gaps of national resources to help defining the moment for a timely and precise request for assistance. 		
2. RESPONSE		
Requesting Part	Assisting Party	Transit Nation
2.1. Request		
<ul style="list-style-type: none"> - Use CECIS Marine as the primary POLFAC communication tool to make a formal request. - Communicate all specific requirements connected to the delivery of the requested equipment (timing, labelling, packaging etc). - Provide any relevant specific information that is missing in Chapter 1. Information by the Contracting Parties (sensitive issues, special circumstances, safety and security issues). - Provide continuous updates regarding the 	<ul style="list-style-type: none"> - Monitor CECIS Marine and have the appropriate contacts within the government to respond to requests for assistance. - By making an offer in CECIS Marine, specify the kind of assistance, at what point in time, for how long it is available and what is the cost. Be as specific as possible. - Ensure adequacy and 	<ul style="list-style-type: none"> - Establish the route for a foreign team or equipment and make arrangements.

<p>incident. N.B. POLWARNs and POLINFs submitted in SafeSeaNet are automatically sent to CECIS Marine and linked to the relevant emergency. Updates can also be made directly in CECIS Marine (Emergency synopsis, Logbook or Request and offer overview).</p> <ul style="list-style-type: none"> - Consider requesting support from the Union Civil Protection Mechanism in form of Host Nation Support experts in case of need. - Consider sending an LO to meet with a team from an assisting Party as early as possible. - Set up appropriate emergency coordination structures. - Inform all relevant national organizations that might be involved when assistance arrives (Customs, Police etc.). - Prepare to support the international assistance teams (entry, logistics). 	<p>sufficient quality of the offered assistance; make sure it fulfils international standards.</p> <ul style="list-style-type: none"> - Start planning for transport, contact authorities of the countries whose territories you will need to transit through. Consider if you need to request transit assistance. - Establish a capability to resupply the response teams while abroad if necessary. - Ensure that experts have the valid necessary travel documents. 	
<p>2.2. Entry</p>		
<ul style="list-style-type: none"> - Establish Reception/Departure Centre (RDC) and Host Nation Support team/cell. - Coordinate relevant Ministries and other services involved in the reception procedures (Telecommunication, Transport, Health and Police Services). - Receive the incoming teams and equipment at the point of entry (provision of LO, instructions etc.). It is recommended for the LO to join the incoming team as early as possible. - Use RDC and Host Nation Support team to provide incoming teams with information. - Put in place shortcut visa procedures or provide visa and work permit waivers when necessary for the entire period of a response operation. - Put mechanisms in place to ensure rapid grant of landing and flight permission. - Put necessary conditions for telecommunication in place, (access to frequencies, bandwidth and satellite use). <p>Provide radio frequencies at the latest upon entry.</p>	<ul style="list-style-type: none"> - Make sure that the Points of entry (airport, seaport, road border crossing) and the place of the Reception and Departure Centre are known and respected. - Implement and maintain procedures to ensure access to transport for rapid deployment of response teams and/or equipment. - Provide all logistical and administrative support that may be required by the team or experts while on mission. - Provide specialized maintenance of your equipment, including bringing specialized spare parts to ensure self-sufficiency for the whole mission. 	<ul style="list-style-type: none"> - Put in place shortcutting visa procedures and provide visa when necessary. - If required, facilitate rapid provision of landing and over flight permission to the assisting Party. - Clarify customs status of response equipment, hazardous materials and their means of transport. - Inform road authorities/police about the status of the transiting assistance goods, equipment and personnel (i.e. waiver of road tax, toll, provision of escort, security, clearing of the roads, safety driving conditions). - Coordinate other relevant Ministries and services involved in the transit procedures (Telecommunication, Transport,

<ul style="list-style-type: none"> - At the border make sure that Police/Immigration knows the status of incoming response personnel. - Clarify customs status of incoming equipment, hazardous materials etc. and their means of transport. - Inform road authorities/police about the status of the incoming assistance goods, equipment and personnel (i.e. waiver of road tax, toll, provision of escort, security, clearing of the roads, safety driving conditions). - Plan the route and provide for necessary transport arrangements (transport means, escorts, maps, material handling equipment, fuel, food etc.) for the incoming teams starting from the point of entry and lasting for the entire operation. - Provide logistic support for the incoming teams and the general maintenance of their equipment. - If applicable, takeover, store, catalogue and distribute in-kind assistance received. - Identify the base of operation, located as close as possible to the existing infrastructure. Take into account the base of operation requirements: access to water, electrical power and sewage, access for cars and trucks, closeness to the disaster site. 		<p>Health and Police Services).</p> <ul style="list-style-type: none"> - Put necessary conditions for telecommunication in place (access to frequencies, bandwidth and satellite use).
<p>2.3. Coordination on-site</p>		
<ul style="list-style-type: none"> - Make arrangements at all levels of the existing emergency command, control and coordination structure to facilitate the coordination of international assistance. - Make incoming teams aware of the requesting Party's command, control and coordination structure. 	<ul style="list-style-type: none"> - Assisting Party's teams/personnel report to the on-site commander (Response Commander, On the Shore Commander or Supreme On-Scene Commander) - at least on a daily basis. 	
<p>2.4. Exit</p>		
<ul style="list-style-type: none"> - Agree upon the points of exit with the assisting Party to ensure the most cost effective and smooth exit transportation route. - Clarify customs status of existing response equipment and their means of transport. 	<ul style="list-style-type: none"> - Together with the requesting Party and the transit nation arrange transportation back. 	<ul style="list-style-type: none"> - Together with the assisting Party facilitate transportation back. - If required, make sure that Police/Immigration is informed about the status

<ul style="list-style-type: none"> - Inform road authorities/police about the status of the existing equipment and personnel (i.e. road tax, toll, provision of escort, security, clearing of the roads, safety driving conditions). - Coordinate relevant Ministries and services involved in the departure procedures (Transport, Health and Police Services). 		<ul style="list-style-type: none"> of transiting response personnel. - Clarify customs status of response equipment, hazardous materials and their means of transport. - Inform road authorities/police about the status of the existing assistance goods, equipment and personnel (i.e. road tax, toll, provision of escort, security, clearing of the roads, safety driving conditions). - Coordinate relevant Ministries and services involved in the transit procedures (Transport, Health and Police Services).
2.5. Safety and security		
<ul style="list-style-type: none"> - Prepare safety brief for the international team(s) including daily safety reporting. - Provide security to the international teams. Make sure the appropriate means are in place to keep personnel, locations, goods and equipment related to the international assistance safe and secure. 	<ul style="list-style-type: none"> - Make sure the appropriate safety and security measures are in place to keep personnel, locations, goods and equipment related to the international assistance safe and secure. 	<ul style="list-style-type: none"> - Guarantee the security of the international teams. Make sure the appropriate means are in place to keep personnel, locations, goods and equipment related to the international assistance safe and secure.
2.6. Financial issues		
<ul style="list-style-type: none"> - Check if appropriate that financial channels and procedures are in place to expedite and facilitate an easy reimbursement of the incoming assistance, if so required. 	<ul style="list-style-type: none"> - Ensure that appropriate financial channels are in place to cost, invoice or waive needs for reimbursement or receive payments, if so required. - Agree on the conditions under which the offer is made. 	<ul style="list-style-type: none"> - Ensure that appropriate financial channels are in place to cost, invoice or waive needs for reimbursement or receive payments, if so required.
2.7. Reporting and lessons learned		

<ul style="list-style-type: none"> - Include evaluation of Host Nation Support into reporting and in lessons learnt meetings after an emergency. 	<ul style="list-style-type: none"> - Include evaluation of Host Nation support into reporting and in lessons learnt meetings after an emergency. 	<ul style="list-style-type: none"> - Include evaluation of transit support into reporting and in lessons learnt meetings after an emergency.
3. LEGAL ISSUES		
Requesting Party	Assisting Party	Transit Nation
<ul style="list-style-type: none"> - Gather information and provide description of the specific provisions in the identified core field of issues, and check their legislation against the overall objective of facilitation of the provision of European and international emergency assistance. - Whenever possible, recognize the relevant professional qualifications of response personnel for the time necessary to carry out the assistance. - Be ready to provide temporary authorization for assisting Party and relevant international organizations to legally operate in the country for the purpose of providing assistance (open bank accounts, enter into contracts and leases, acquire and dispose of property and instigate legal proceedings). - Consider granting fast track procedures/ legal exemptions, in particular: <ol style="list-style-type: none"> 1. Responder immunity (partial or complete). Ideally before accepting assistance, agree with the assisting Party on the principles for compensating the potential damage suffered by third parties. 2. Product immunity protecting the supplier/manufacturer (partial or complete). 3. Exempting the requested/ accepted equipment from all custom duties, taxes, tariffs or any governmental fees, and exempting them from all export and import restrictions. 4. Simplifying and minimizing documentation requirements for 	<ul style="list-style-type: none"> - Clarify the mechanisms for co-operation between governmental actors and non-governmental actors of the assisting Party and the requesting Party. - Simplify and minimize documentation requirements for export. - Consider waiving all claims against the requesting Party or any other Contracting Party for any damage sustained, except in cases of gross negligence or willful misconduct. 	<ul style="list-style-type: none"> - Simplify and minimize documentation requirements for transit.

<p>export and import.</p> <ol style="list-style-type: none">5. Permitting the re-exportation of goods and equipment used, in the event that the requesting Party is requested or required by the assisting Party to return the items.6. Waiving or reducing inspection requirements (where this is difficult, consider using pre-clearance processes where possible to clear equipment more rapidly).7. Arranging for inspection and release outside of business hours and/or at a place outside the customs office to avoid unnecessary delay.8. Visa regulations and immigration inspection.		
---	--	--

Annex 5. POLREP Reporting Template

POLREP Reporting Template on Pollution of Oil and Other Harmful Substances

HEADING	REMARKS
---------	---------

URGENT

DTG (date time group)

POLREP

NATIONAL IDENTIFIER AND SERIAL NUMBER

ITEM NUMBER	REMARKS
-------------	---------

1. DATE AND TIME

2. POSITION

3. INCIDENT

4. OUTFLOW

5. ACKNOWLEDGE

40. DATE AND TIME

41. POSITION AND/OR EXTENT OF POLLUTION ON/ABOVE/IN THE SEA

42. CHARACTERISTICS OF POLLUTION

43. SOURCE AND CAUSE OF POLLUTION

44. WIND DIRECTION AND SPEED

- 45. CURRENT DIRECTION AND SPEED**

- 46. SEA STATE AND VISIBILITY**

- 47. DRIFT OF POLLUTION**

- 48. FORECAST OF LIKELY EFFECT OF POLLUTION AND ZONES AFFECTED**

- 49. IDENTITY OF OBSERVER/REPORTER
IDENTITY OF SHIPS ON SCENE**

- 50. ACTION TAKEN**

- 51. PHOTOGRAPHS TAKEN**

- 52. NAMES OF OTHER STATES & ORGANIZATIONS INFORMED**

- 53. REPORT ON OILED WILDLIFE**

- 54. ACTION TAKEN ON OILED WILDLIFE**

- 55. FORECAST OILING OF WILDLIFE**

- 56. EVIDENCE TAKEN FROM OILED WILDLIFE**

- 57. - 59. SPARE FOR ANY OTHER RELEVANT INFORMATION**

- 60. ACKNOWLEDGE**

- 80. DATE AND TIME**

- 81. REQUEST FOR ASSISTANCE**

- 82. COST**

- 83. PRE-ARRANGEMENTS FOR THE DELIVERY OF ASSISTANCE**

- 84. TO WHERE ASSISTANCE SHOULD BE RENDERED AND HOW**

- 85. NAMES OF OTHER STATES AND ORGANIZATIONS**

- 86. CHANGE OF COMMAND**

- 87. EXCHANGE OF INFORMATION**

88. REQUEST FOR WILDLIFE RESPONSE ASSISTANCE

89. PRE-ARRANGEMENT FOR WILDLIFE RESPONSE ASSISTANCE

90. TO WHERE WILDLIFE ASSISTANCE SHOULD BE RENDERED

91. - 98. SPARE FOR ANY OTHER RELEVANT REQUIREMENTS OR INSTRUCTIONS

99. ACKNOWLEDGE

Annex 6. POLREP Sample Messages

POLREP Sample Message

Part 1 Warning of Pollution

Heading and Item Numbers

POLREP Telefax Message

Address

FROM DENMARK
TO SWEDEN
HELSINKI COMMISSION

Traffic priority

URGENT

Date time group (UTC)

030730

Message identification

POLREP

National identification and serial number

DK 1/1

1. Date and time (UTC)

030700

2. Position

5538N1243E

3. Incident

TANKER GROUNDING

4. Outflow

NOT YET CRUDE OIL

5. Acknowledge

ACKNOWLEDGE

POLREP
 Sample Message

Full Report Using Part 1, 2 and 3

<u>Heading and Item Numbers</u>	<u>POLREP Message</u>
Address	FROM DENMARK TO SWEDEN GERMANY
Traffic priority	URGENT
Date time group (UTC)	030915
Message identification	POLREP
National identification and serial number	DK 1/2 - DK 1/1 FOR SE
1. Date and time (UTC)	030900
2. Position	5538N1243E
3. Incident	TANKER GROUNDING
4. Outflow	CRUDE OIL, 800 TONS ESCAPED
41. Position and/or extent of pollution on/above/in the sea	OIL SLICK EXTENDING 1 MILE TO THE SOUTH, WIDTH 0.3 MILES
42. Characteristics of pollution	VENEZUELA CRUDE. VISCOSITY 2983 CST AT 38C. HIGHLY VISCOUS
43. Source and cause of pollution	DK TANKER ESSO BALTICA OF COPENHAGEN, 5000 GRT, CALL SIGN OVQZ. THREE WING TANKS DAMAGED
44. Wind direction and speed	000 - 10
45. Current direction and speed	180 - 0.2
46. Sea state and visibility	0.5 - 10
47. Drift of pollution	180 - 0.5
48. Forecast of likely effect of pollution on/above/in the sea	COULD REACH FALSTERBO WITHIN HOURS
49. Identity of observer/reporter Identity of ships on scene	RE. 43 ABOVE
50. Action taken	TWO DK STRIKE TEAMS WITH HIGH OIL RECOVERY CAPABILITY EN ROUTE. ETA SPILL SITE 031000.

51. Photographs taken	OIL SAMPLES TAKEN. TELEX 64471 SOK DK
52. Names of other states & organizations informed	SE AND HELCOM
53. Spare	NAVIGATIONAL WARNING ISSUED AS LYNGBY RADIO NAV. WARN. NO 57
81. Request for assistance	FOR SWEDEN: REQUEST ONE A-CLASS (M1 SYSTEM) AND ONE B-CLASS VESSEL (M3 SYSTEM) FOR DE: REQUEST ONE STRIKE TEAM WITH 500 M HIGH SEA BOOM AND HIGH CAPACITY SKIMMER
82. Cost	REQUEST INFORMATION ON COST RATE FOR ASSISTANCE UNDER ITEM 81
83. Pre-arrangements for the delivery of assistance	FORMALITIES REGARDING BORDER PASSAGE WILL BE CLEARED WHEN ITEM 81/3 CONFIRMED.
84. To where assistance should be rendered and how	SITE OF GROUNDING. CONTACT GUNNAR THORSON OF VHF CHANNEL 16. CALL SIGN OWPB. SOSC KNUD HANSEN ON BOARD GUNNAR THORSON
99. Acknowledge	ACKNOWLEDGE

POLREP Sample Message

Part 3 Used as Reply to a Request for Assistance

Heading and Item Numbers

Address	FROM SWEDEN TO DENMARK
Traffic priority	URGENT
Date time group (UTC)	031115
Message identification	POLREP
National identification and serial number	YOUR DK 1/2 REFERS
80. Date and time (UTC)	031100
81. Request for assistance	KBV 034 AND KBV 048 WITH OIL BOOMS AND SKIMMERS ARE AVAILABLE
82. Cost	TOTAL COST FOR KBV 034 AND KBV 048 WILL BE APPROXIMATELY 6600 SEK PR. HOUR ON SITE
84. To where assistance should be rendered and how	KBV 048 ETA SPILL AREA 031200 KBV 034 ETA SPILL AREA 031400
99. Acknowledge	ACKNOWLEDGE

POLREP Sample Message

Part 1 Used as Exercise Message

<u>Heading and Item Numbers</u>	<u>POLREP Message</u>
Address	FROM FINLAND TO RUSSIA SWEDEN HELSINKI COMMISSION
Traffic priority	URGENT
Date time group (UTC)	060300
Exercise identification	EXERCISE
Message identification	POLREP
National identification and serial number	FI 1/1
1. Date and time (UTC)	060235
2. Position	5959N2533E
3. Incident	CARGO SHIP COLLISION
4. Outflow	NOT YET HEAVY FUEL OIL. APPROXIMATELY 400 TONS ON BOARD DAMAGED VESSEL
5. Acknowledge	ACKNOWLEDGE
Exercise identification	EXERCISE EXERCISE EXERCISE

Annex 7.

Nomenclature for Describing the Oiling of the Shore

This annex concentrates on the common terminology³⁷ to be used when describing the pollution on the shore in POLINF or POLFAC report. The terminology should also be used when describing the status of the shore pollution to the assisting teams in situational briefings.

Oil character / Debris type

- a) Fresh: unweathered, low viscosity oil
- b) Mousse (“chocolate mousse”): emulsified oil (oil and water mixture)
- c) Tar balls or patties: discrete balls or patties on a beach or adhered to rock or coarse sediment shoreline. Tar ball diameters are generally <0,1m and patties are 0,1m to 1m.
- d) Tar: weathered coat or cover of tarry, almost solid consistency
- e) Surface oil residue: consists of non-cohesive, oiled, surface sediments, either as continuous patches or in coarse sediment interstices.
- f) Asphalt pavement: cohesive mixture of oil and sediments
- g) Debris: can consists of logs, vegetation, rubbish or general debris including spill response items like sorbents, booms etc.

Categories of oil coverage

- a) Continuous: >90 %
- b) Broken: 51 - 90 %
- c) Patchy: 11 - 50 %
- d) Sporadic: 1 - 10 %
- e) Trace: <1 %

Categories of oil thickness

- a) Pooled or thick oil: generally consists of fresh oil or mousse accumulations >1 cm thick.
- b) Cover: between >0,1 cm and 1 cm thick
- c) Coat: between >0,01 cm and 0,1 cm thick coating. It can be scratched off with fingernail on coarse sediments or bedrock.
- d) Stain: <0,01 cm thick. It cannot be scratched off easily on coarse sediments or bedrock.
- e) Film: transparent or translucent film or sheen

³⁷ The terminology is based on the POLSCALE report.

Categories of degrees of shoreline oiling

- a) Very light
- b) Light
- c) Moderate
- d) Heavy
- e) Very heavy
- f) No oil

Types of shoreline materials

- a) Bedrock outcrops
- b) Boulder (>256 mm dia.)
- c) Shingle or cobble (50 - 256 mm dia.)
- d) Gravel (2- 50 mm dia.)
- e) Sand (0.06-2 mm dia.)
- f) Mud/silt/clay (<0.06 mm dia.)
- g) Manmade

Categories of slope of the shoreline

- a) Low: <30 degrees
- b) Medium: 31 - 60 degrees
- c) High: >60 degrees

Wave exposure of the shoreline

- a) High: when the shoreline is entirely exposed to the action of the waves coming from the sea
- b) Medium: when the shoreline is partly exposed to the waves and partly sheltered
- c) Low: when the shoreline is not directly exposed to the action of the waves coming from the open sea (sheltered shoreline)























Categories	Oil coverage			Symbols and abbreviations
Trace > 0 – < 1 %				 TR
Sporadic 1 – 10 %	10 %			 SP
Patchy 11 – 50 %	20 %			 PT
	30 %			
	40 %			
	50 %			
Broken 51 – 90 %	60 %			 BR
	70 %			
	80 %			
	90 %			
Continuous 91 – 100 %				 CN

Figure 4. Visual aid for estimating oil scatter on the shore.

Annex 8. List of Waypoints Used in Aerial Surveillance

National indicators are as follows:

Denmark	DK
Estonia	EE
Finland	FI
Germany	DE
Latvia	LV
Lithuania	LT
Poland	PL
Russia	RU
Sweden	SE

The reference points are situated in the Baltic.

<u>NUMBER</u>	<u>NAME</u>	<u>POSITION</u>	
DENMARK			
DK1		57° 00' N	010° 42' E
DK2		56° 22' N	011° 24' E
DK3		56° 07' N	010° 55' E
DK4		54° 43' N	010° 42' E
DK5		54° 30' N	012° 00' E
DK6		54° 46' N	012° 50' E
DK7		54° 54' N	014° 00' E
DK8	DETNI (SDG-2)	54° 55' N	014° 20,7' E
DK9		55° 00' N	015° 53' E
DK10		55° 30' N	016° 00' E
DK11		55° 13' N	014° 00' E
DK12	DISGO	55° 09' N	012° 44' E
DK13	KOPIM	56° 08' N	012° 30' E
DK14		57° 45' N	010° 44' E
DK28		58° 08' N	010° 16' E
DK29		55° 47' N	004° 17' E
DK30		56° 11' N	004° 57' E
DK31		55° 15' N	004° 57' E
DK32		56° 30' N	005° 55' E
DK33		56° 50' N	006° 45' E
DK34		55° 15' N	007° 40' E
DK 52	Läsö Trindel	57° 28' N	11° 18' E

DK 53	Anholt Ö	56° 45' N	11° 45' E
DK 54	Anholt V	56° 41' N	11° 00' E
DK 55	Gilleleje N	56° 18' N	12° 00' E
DK 56	Sletterhage	56° 05' N	10° 24' E
DK 57	Kronborg	56° 03' N	12° 37' E
DK 58	Sj. Odde	56° 01' N	11° 05' E
DK 59	Hatter Barn	55° 53' N	10° 49' E
DK 60	Romsö Tue	55° 34' N	10° 49' E
DK 61	Drogden	55° 32' N	12° 42' E
DK 62	Köge Bugt	55° 26' N	12° 35' E
DK 63	Lille Bält	55° 25' N	09° 41' E
DK 64	Hov	55° 12' N	11° 00' E
DK 65	Krigers Flak	55° 07' N	12° 50' E
DK 66	Vejrö	55° 04' N	11° 16' E
DK 67	Mön	54° 03' N	12° 38' E
DK 68	Grönsund	54° 48' N	12° 14' E
DK 69	Keldsnor	54° 41' N	10° 42' E
DK 70	Gedser	54° 34' N	11° 58' E
DK 71	Hammeren	55° 19' N	14° 46' E
DK 72	16 öst	55° 25' N	16° 00' E
DK 73	Due Odde	54° 59' N	15° 04' E

ESTONIA

EE 1	MUUGA	59° 31,7' N	024° 58,93' E
EE 2	PRANGLI	59° 37' N	025° 02' E
EE 3	MOHNI	59° 41' N	025° 48' E
EE 4	KUNDA	59° 31' N	026° 33' E
EE 5	SILLAMÄE	59° 24,5' N	027° 46' E
EE 6	MP1	59° 30' N	027° 46' E
EE 7	MP2	59° 38' N	026° 38' E
EE 8	MP3	59° 55' N	026° 22' E
EE 9	MP4	59° 51' N	026° 00' E
EE 10	MP5	59° 47' N	024° 37' E
EE 11	MP6	59° 30' N	023° 30' E
EE 12	1MP7	59° 04' N	021° 20' E
EE 13	1MP8	58° 25' N	021° 00' E
EE 14	1MP9	57° 50' N	022° 03' E
EE 15	1MP10	58° 01' N	022° 34' E
EE 16	3MP7	59° 00' N	021° 00' E
EE 17	3MP8	58° 02' N	020° 30' E
EE 18	3MP9	57° 49' N	021° 40' E
EE 19	3MP10	59° 00' N	021° 46' E
EE 20	RUHNU	57° 46' N	023° 16' E
EE 21	1MP11	57° 56' N	023° 36' E
EE 22	1MP12	58° 09' N	024° 15' E

EE 23	1MP13	58° 17' N	023° 30' E
EE 24	VAINAMERI	58° 45' N	023° 15' E
EE 25	OSMUSSAAR	59° 18' N	023° 21' E
EE 26	PALDISKI	59° 20' N	024° 03' E
EE 27	NAISA	59° 32,45' N	024° 33,85' E

FINLAND

FI 1	Kemi1	65° 23,1' N	24° 06,0' E
FI 2	Nahkiainen	64° 36,7' N	23° 54' E
FI 3	Ulkokalla	64° 19,8' N	23° 26,8' E
FI 4	Valassaaret	63° 26,1' N	21° 04,5' E
FI 5	Norrskär	63° 14,0' N	20° 36,4' E
FI 6	Ritgrund	63° 25,5' N	21° 30,8' E
FI 7	Strömmings-Bådan	62° 58,8' N	20° 44,6' E
FI 8	Santio	60° 27,3' N	27° 43,6' E
FI 9	Sälskär	60° 24,7' N	19° 35,8' E
FI 10	Haapasaari	60° 17,2' N	27° 11,3' E
FI 11	Enskär	60° 13,2' N	19° 18,8' E
FI 12	Kotkan majakka	60° 10,3' N	26° 39,2' E
FI 13	Airisto	60° 17,0' N	22° 03,0' E
FI 14	Kaunissaari	60° 20,8' N	26° 46,6' E
FI 15	Tiiskeri	60° 09,7' N	26° 15,7' E
FI 16	Söderskär	60° 06,6' N	25° 24,6' E
FI 17	Jungfruskär	60° 08' N	21° 04' E
FI 18	Helsingin kasuuni	59° 56,9' N	24° 55,6' E
FI 19	Flötjan	59° 48,5' N	19° 47,1' E
FI 20		59° 40,0' N	23° 55,0' E
FI 21	Bogskär	59° 30,3' N	20° 21,0' E
FI 22		59° 00,0' N	21° 00,0' E
FI 23	Kalbådgrund	59° 59,1' N	25° 36,1' E
FI 24	Porkkalan majakka	59° 52,1' N	24° 18,1' E
FI 25	Utö	59° 46,9' N	21° 22,3' E
FI 26	Russarö	59° 46,0' N	22° 57,1' E
FI 27	Jussarö	59° 47,4' N	23° 33,2' E

GERMANY

G20		54° 06,80' N	010° 59,00' E
G21		54° 41,20' N	012° 56,60' E
G22		54° 12,00' N	013° 19,00' E
G23		54° 13,00' N	013° 50,00' E
G24		54° 55,00' N	013° 34,00' E
G25		54° 50,00' N	012° 41,00' E
G26		54° 28,00' N	011° 39,00' E
G27		54° 40,00' N	011° 00,00' E

G28	54° 50,30' N	009° 51,50' E
G29	54° 50,20' N	008° 23,00' E
G31	54° 25,00' N	010° 40,00' E
SDG1	54° 41,20' N	012° 56,60' E
SDG2	54° 55,00' N	014° 20,70' E
SDG3	55° 15,00' N	014° 20,00' E
SDG4	55° 09,80' N	013° 02,20' E
SDG5	54° 50,00' N	012° 41,00' E

LATVIA

LV	57° 54' N	20° 15' E
LV	56° 00' N	19° 14' E
LV	57° 54' N	21° 30' E
LV	56° 00' N	19° 52' E

LITHUANIA

LT 1	55°20'N	20°57'E
LT 2	55°34'N	20°10'E
LT 3	55°47'N	19°32'E
LT 4	55°56'N	19°06'E
LT 5	56°02'N	19°28'E
LT 6	56°02'N	20°05'E
LT 7	56°02'N	20°50'E

POLAND

PL 1	54° 46' N	19° 16' E
PL 2	55° 50' N	18° 52' E
PL 3	55° 50' N	18° 24' E
PL 4	55° 05' N	15° 35' E
PL 5	54° 46' N	15° 25' E
PL 6	54° 46' N	14° 53' E
PL 7	54° 21' N	14° 10' E
PL 8	53° 58' N	14° 23' E
PL 9	55° 29' N	18° 11' E
PL 10	55° 00' N	18° 20' E
PL 11	54° 40' N	19° 00' E
Rebiechowo	54° 22,41 N	18° 28,05 E

RUSSIA

Baltic Proper

RU 1		59° 15' N	22° 00' E
RU 2		59° 00' N	21° 10' E
RU 3		57° 55' N	20° 30' E
RU 4		55° 40' N	19° 00' E
RU 5		54° 50' N	19° 30' E
RU 6		55° 20' N	19° 30' E
RU 7		55° 40' N	19° 40' E
RU 8		56° 15' N	20° 10' E
RU 9		57° 33' N	21° 00' E
RU 10		59° 00' N	21° 20' E

Gulf of Finland

RU 11	City of St. Petersburg		
RU 12	Island Kotlin		
RU 13	Island Seskar		
RU 14	Island Moschny		
RU 15	Island Tjutersy		
RU 16	Ustj-Luga Town		
RU 17	Ustj-Narva Town		
RU 18	Island Gogland		
RU 19	Vyborg Town		

SWEDEN

SE 101	Malören	65° 32' N	23° 34' E
SE 102		65° 21,8 N	23° 55' E
SE 103	Farstugrund	65° 20' N	22° 45' E
SE 104		64° 30' N	21° 30' E
SE 105		63° 40' N	21° 30' E
SE 106	Västra Kvarken	63° 40' N	20° 40' E
SE 107		63° 29,1 N	20° 41,8 E
SE 108		63° 29' N	20° 27' E
SE 109		63° 20' N	20° 24' E
SE 110		62° 42,3 N	19° 31,5 E
SE 111	Vänta Litets grund	62° 30' N	18° 17' E
SE 112	Brämön	62° 13' N	17° 45' E
SE 113	Västra Banken	60° 53' N	17° 56' E
SE 201		60° 36,6 N	19° 13' E
SE 202	Understen	60° 17' N	18° 55' E
SE 203	Svenska Björn	59° 33' N	20° 01' N
SE 204		58° 46,8 N	20° 28,7 E
SE 205	Landsort	58° 44' N	17° 52' E

Annex 8. List of Waypoints Used in Aerial Surveillance
 HELCOM Response Manual

SE 206		58° 20' N	17° 50' E
SE 207		58° 13,6 N	18° 39,5 E
SE 208		58° 03,9 N	19° 43' E
SE 209		57° 54,7 N	20° 24,9 E
SE 210		57° 40' N	17° 30' E
SE 211		56° 50' N	18° 30' E
SE 212		55° 57,3 N	19° 04' E
SE 301	Ölandsbroen	56° 41' N	16° 24' E
SE 302	Ölands Södra grund	56° 04' N	16° 41' E
SE 303		55° 52,9 N	18° 54' E
SE 304		55° 55,3 N	18° 21,8 E
SE 305		55° 21,3 N	16° 30,5 E
SE 306		55° 44,8 N	15° 43' E
SE 307		55° 41,5 N	15° 02,6 E
SE 308	Bornholms Gattet	55° 18,7 N	14° 27,6 E
SE 309		55° 10' N	14° 00' E
SE 310		54° 57,8 N	13° 59,7 E
SE 311		55° 01,3 N	13° 47,1 E
SE 312		55° 00,6 N	13° 08,8 E
SE 313		55° 20,2 N	12° 38,5 E
SE 314		55° 40' N	12° 56,3 E
SE 315		56° 02,7 N	12° 40,9 E
SE 316		56° 13' N	12° 21,8 E
SE 401		56° 18,2 N	12° 05,3 E
SE 402		56° 30' N	12° 30' E
SE 403		56° 30,5	12° 08,9 E
SE 404		57° 30' N	11° 30' E
SE 405		57° 27' N	11° 23,9 E
SE 406		57° 49' N	11° 02,9 E
SE 407		58° 08' N	10° 32,5 E
SE 408		58° 15,7 N	10° 01,8 E
SE 409		58° 30,7 N	10° 08,8 E
SE 410		58° 45,7 N	10° 35,7 E

Annex 9. HELCOM Response Grid

The Supreme On-Scene Commander (SOSC) determines the operations area for a joint response operation at sea. This is done by using a HELCOM Response Grid. The SOSC defines the sea chart and the map scale that will be used in the operation, as well as the central point of the HELCOM Response Grid. The central point can be a LAT - LONG position or a fixed structure (such as a light house, navigational aid etc.).

After defining the Strike Teams the SOSC gives each team its working area using the Grid cell IDs. The SOSC can communicate on VHF frequency for instance: "Strike Team Alpha, your working area is the following: B4, C3, C4, D2, D3, D4."

The Grid (printed on transparent material) is placed on the sea chart of the leading Strike Team vessel showing the working area. The Strike Team Leader uses a Grid cell ID to inform the SOSC when a Grid cell has been cleaned from oil.

Every Contracting Party can produce a digital version of HELCOM Response Grid if deemed necessary.



HELCOM response grid

1. Be sure that all units use seacharts of the same scale.
2. Place the reference point in the given position.
3. Mark your response area.

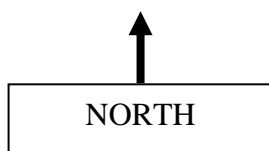

A1	A2	A3	A4	A5	A6	A7	A8
B1	B2	B3	B4	B5	B6	B7	B8
C1	C2	C3	C4	C5	C6	C7	C8
D1	D2	D3	D4	D5	D6	D7	D8
E1	E2	E3	E4	E5	E6	E7	E8
F1	F2	F3	F4	F5	F6	F7	F8
G1	G2	G3	G4	G5	G6	G7	G8
H1	H2	H3	H4	H5	H6	H7	H8

Annex 10.

Terms of Reference of the HELCOM Exercise Development and Monitoring Team (HEDMOT)

1. HELCOM Exercises and the HEDMOT

The HELCOM Exercise Development and Monitoring Team (HEDMOT) is established to support a long-term approach to HELCOM Response exercises. The role of HEDMOT is both to formulate proposals for exercise aims that corresponds to identified needs and to monitor and evaluate ongoing exercise projects.

According to the HELCOM Response Manual, all HELCOM Response exercises – at sea, on the shore and combined – support the development of HELCOM cooperation on the response to marine pollution. Decisions on the exercise programme including the types of exercises, aims and goals for the exercises, time for the execution and appointment of Lead Countries are taken during the meetings of the Response Group (cf. HELCOM SEA 1/2000, 5/3, Paragraph 4.48).

The process for analysing the exercise needs, propose exercise aims, and decide future exercises is described in the HREP process (Annex 11). The processes for planning, executing, and evaluating exercises are described in the Practical Guide for HELCOM Response Exercises, a document listed in the HELCOM Response work programme and regularly revised.

2. Tasks

The HEDMOT consists of representatives from four Contracting Parties: The current Exercise Project Lead Country, last year's Lead Country (Chair), and the Exercise Project Lead Countries for the coming two years. The European Union is not included in this rotation, but may participate when appropriate. It is assumed that the participating Contracting Parties ensures that the group has access to relevant expertise to carry out its tasks, for instance regarding the combatting of marine pollution, exercises, and evaluation.

The HEDMOT has the following tasks:

- to follow-up and support the planning of the yearly exercise project as described in the Practical Guide for HELCOM Response Exercises,
- to evaluate the yearly exercise project, and submit an exercise evaluation report to HELCOM Response no later than two months after the final exercise, as described in the Practical Guide for HELCOM Response Exercises,
- to draft an implementation plan for the lessons and best practices identified in the exercise project,
- to compile a list of development needs that can be met with exercises, based on lessons identified from exercises and operations as well as research and other relevant sources of knowledge, as described in the HREP process (Annex 11),

- to compile a list of prioritized exercise aims based on the list of development needs, where each aim is associated with suggestions for exercise types, as described in the HREP process (Annex 11),
- to, after dialogue with the Contracting Parties, propose aims and Lead Country for coming exercise projects, and
- to, if necessary and appropriate, propose updates of the HELCOM Response Manual, the Practical Guide, and the HREP.

3. Working mode

- The group will arrange meetings: online, telephone or physical according to need.
- When possible, physical meetings can be organized back-to-back with other HELCOM Response WG related events.
- The group (HEDMOT chair) will report to HELCOM Response on progress made.
- The change of the composition of HEDMOT takes place January 1st each year.

Annex 11. The HREP process

The HELCOM Response Exercise Plan (HREP) is a yearly updated multiannual exercise plan. A multiannual plan ensures a long-term perspective and continuity in the development of HELCOM cooperation on the response to marine pollution. It also gives the Contracting Parties enough time to plan and prepare for specific exercises. Yearly updates ensure that new circumstances, including identified capability shortfalls, are reflected in the exercises, but also that any necessary changes in already decided exercise can be handled.

The HELCOM Exercise Development and Monitoring Team (HEDMOT) has a central role in the HREP process. The HEDMOT Terms of Reference are found in Annex 10. HELCOM Response decides any changes in the HREP.

The HEDMOT updates the HREP in a cyclic, one-year process. The first three steps are the needs analysis taking into account the gaps identified and capabilities that are to be focused on, development of a list of development needs, and the development of a list of potential exercise aims. The needs analysis would make use of previous exercise project outcomes, lessons identified and improvement plans conducted; trends and new developments within the field of marine pollution; lessons identified from real response; research; as well as other aspects deemed necessary by the HEDMOT and HELCOM Response working group.

The HEDMOT then compiles a list of HELCOM Response development needs. This list is used to develop a list of potential exercise aims, where each aim is elaborated together with suggestions for exercise type and overall exercise design.

However, it is neither necessary, nor appropriate considering the work efforts required, to carry out these first three steps in full each year. Instead, a full analysis is carried out every fourth year, with only limited reviews in the years in between, taking into account especially important new aspects. In this way, the responsibility for the comprehensive updates will fall on different constellations of Contracting Parties each time. The four-year perspective also allows for a long-term time-perspective in the HELCOM Response exercise planning process. When conducting a comprehensive needs analysis, reinforcing the HEDMOT with analysts should be considered.

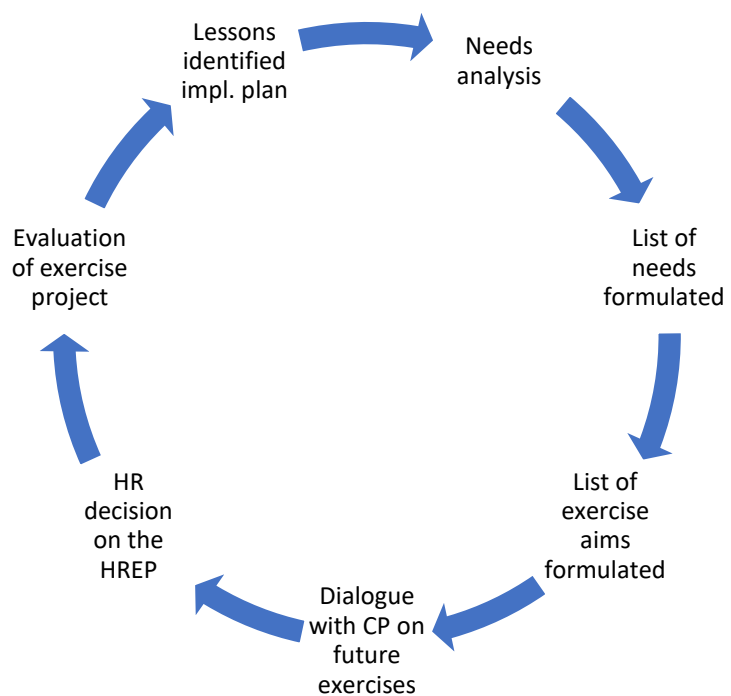

After consultations with the Contracting Parties, the HEDMOT should propose Lead Countries. The Lead Countries then, choosing from the list of aims, propose an aim for the exercise project for the HELCOM Response to decide on. Together with exercise aims for the coming years. This is the fourth step, and the list of needs and the list of aims, together with the proposals for future exercise projects, should be adopted by the HELCOM Response as a fifth step. Lead Countries and aims should be decided at least four years before the execution of an exercise project.

The sixth step in the HREP process is the HEDMOT evaluation of the exercise project.

The seventh and final step is the development of an implementation plan for the identified lessons and best practices. These lessons and best practices fall into three main categories:

- 1) Lessons and best practices related to the processes and methods in the Manual and the ability of the Contracting Parties in relations to these. These lessons could for instance highlight the need for further training, the need for development of methods and procedures, or the need for testing capabilities and abilities. Implementation can be in the form of aims or objectives in future exercises, but also in the form of research, technology development, etc.
- 2) Lessons and best practices related to the process for planning. This could for instance be the need for revisions of the content in the planning conferences or in a template and would in most cases result in changes in the *Practical Guide for response exercises*, a regularly revised document listed in the HELCOM Response work programme.
- 3) Lessons and best practices of a practical nature, for instance how to arrange logistic support, issues regarding security clearance, the design of observer programmes, or the formulation of indicators in the evaluation. These lessons are primarily implemented through the inclusion in Appendices to the Practical Guide.

HELCOM Response can adapt these lessons and best practices together with a plan for their implementation. The adoption of the implementation plan is the seventh and final step in the HREP process, and results in the update of documents such as the HREP and the Practical Guide, including Appendices, but also in proposals for activities that are not related to exercises, such as research.

In figure below, the process is illustrated from the perspective of a specific HELCOM exercise project, *BALEX 20XX*. It is important that the Lead Country and the aim are decided well in advance of the execution of the exercise project to allow enough time for planning and preparations.

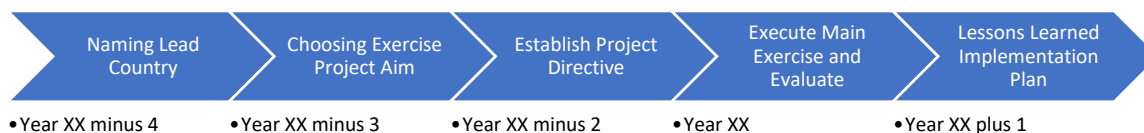

Annex 12. Guidelines for Oil Sampling

The oil sampling activities described in this annex are limited to forensic investigations. Forensic investigations may form part of a whole chain of activities undertaken to gather information about a given oil spill.

Sampling is the first step in the process of obtaining information about the spill. Samples can be taken from water surface, suspected polluter or shoreline. Information about the physical and chemical properties as well as behaviour will facilitate decision-making during response to the oil spill.

These guidelines are intended to aid the sample taking person in the proper procedures involved in oil sampling for source identification. If the sampling is not done in a proper way the results of the analysis will not be as accurate as they could otherwise be.

1. TRAINING

1.1. All personnel involved in sampling needs to be trained to ensure that the sampling is performed in a correct way. This is also something that will be questioned by lawyers in the legal process following an oil spill. When samples are taken at a suspected polluter it is important that the sampler has been working on board ships. This will ensure that he/she has knowledge and experience of the piping systems in machinery spaces and cargo systems.

1.2. Training should be ongoing to make sure the level of competence is maintained over time.

2. GENERAL REMARKS

2.1. *All* spills encountered and *all* potential sources of spills should be sampled. It is important to take samples from both spill and source even when it is clear where the spill originates from. From the outset, the type of sampling equipment and routines described in this document should be used.

2.2. Sampling procedures which are connected to liability investigations must be performed with great care and accuracy concerning spills as well as suspected sources. Every action should be taken to prevent a deterioration in the samples' value as evidence.

2.3. Even if an oil spill has scattered, and only a thin sheen remains, every possible effort should be made to take at least a small sample. No sample volume is too small to be shipped to the laboratory. The laboratory can often analyze very small oil samples – for example, water samples that seemingly consist of pure water or sample pads that do not show any visible traces of oil.

2.4. If any part of the oil spill differs in any respect from other parts, take extra samples to check if more than one spill has occurred in the area.

2.5. If the spill response operation continues for more than one day, samples should be taken every day to make it possible to determine the degree of weathering of the oil as well as possible contamination by other oils.

2.6. If an oil sample is suspected of containing contaminants, take blank samples, if possible, of the contaminant. Surface waters in harbours and estuaries may contain traces of various petroleum products. When spills in such waters are sampled, it is therefore also important to provide the laboratory with blank samples of the water.

2.7. Samples and sampling equipment should be handled and stored so that the samples cannot be manipulated, mixed up or be contaminated by other substances. Samples should be handled as legal evidence and should be kept in a “chain of custody” until identification and possible legal procedures have been completed. Therefore, always use the sealable and individually numbered safety bags described later in this document.

2.8. A bottle containing a sample should not be placed in the sampling kit containing the clean equipment. Reusable sampling equipment should always be very carefully cleaned, and put into clean plastic bags, before restoring it to the sampling kit case. Used sample bottles must not be used again - not even after careful washing.

2.9. Make notes of all relevant information about samples and sample sites. Use a digital camera or a video camera to record observations which are considered important to the investigation.

2.10. The samples should be sent as soon as possible to the laboratory. Quick handling of samples is important. If the transmission is delayed, the samples should be kept at a temperature of less than +4°C (but not be frozen).

2.11. Used equipment should be replaced as soon as possible so that the sampling kit case is always fit for use, and so that new samples can always be quickly packed and sent away.

3. OIL SAMPLING FOR THE PURPOSE OF SOURCE IDENTIFICATION

Thick waterborne layers, oil globules and tar balls

3.1. Focus the sampling on thick parts of the spill. If the spill is large, it is important to take samples in several positions within the spill to get a representative sample selection.

Use of a sample bottle directly

3.2. Globules, balls and thick parts can often be sampled directly with a sample bottle. Fill the bottle with as many balls as possible or skim oil from the surface by repeated sweeps with the bottle. Remove the water which has entered the bottle. One method of doing this is to close the lid and hold the bottle upside down for a minute to let the oil float upwards to the bottom of the bottle so that the water can be drained by careful opening of the lid. Then continue to skim oil and try to get the bottle approximately three-quarters full of de-watered oil (i.e. 50-70 ml). Further techniques to concentrate the oil into the sampling bottle:

Polyethylene cornet or conical Teflon® bag

Floating brown oil layers or tar balls on the water surface can often be sampled by a polyethylene cornet. The cornet should have a wide hem into which a metal ring can be threaded. First cut off the tip of the cornet as shown in the picture.

A holder is fitted onto the ring and by means of this holder the device can be fastened to a boathook or the like.

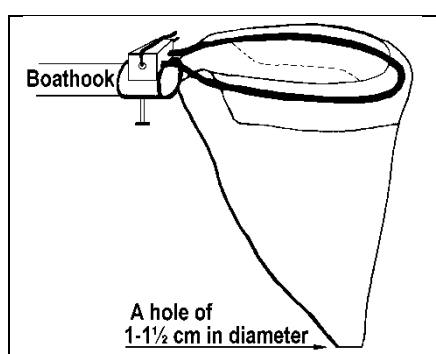
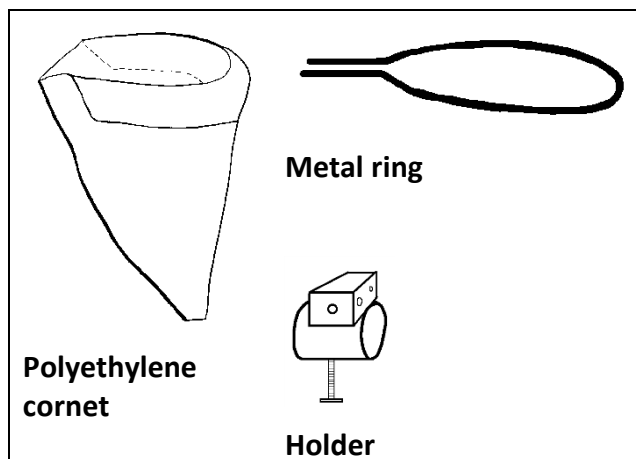

The assembled device is swept through the spill so as to skim as much oil as possible.

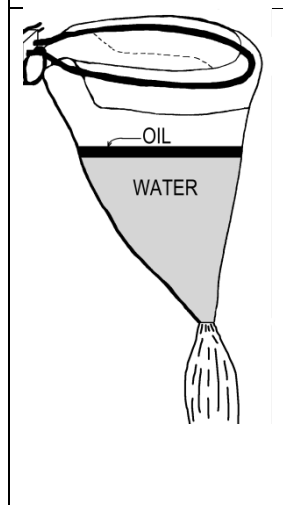
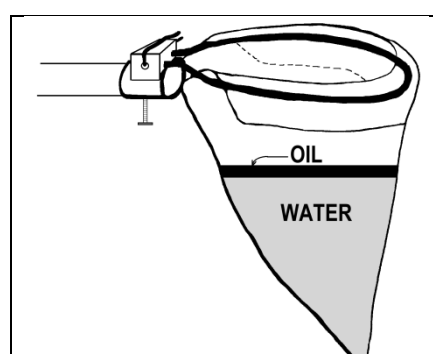

The water in the cornet is slowly let out and the drainage is stopped when the last drop of water has escaped. Then the oil in the cornet is filled into a 100 ml wide-neck sample bottle. The same procedure is then repeated once or several times until the bottle is approximately three-quarters full of de-watered oil.

N.B. Do not fill the bottle to a higher level than up to 2 cm below the lower edge of the lid.

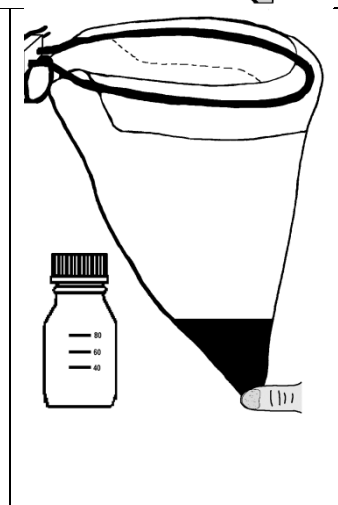

Clean bucket with small holes

3.3. One useful refinement of the skimming technique involves the use of a bucket with small holes in the bottom allowing much of the water to drain away from the oil. After drainage of water, the skimming technique may be repeated several times to increase the amount of oil in the bucket. Finally, the oil may be transferred to the sample container by means of a stainless-steel or Teflon® scraper used to scrape the sides of the bucket.

Sampling of thin oil films (sheens)

3.4. A special Teflon® pad can be used if the oil film on the water surface is very thin (“rainbow sheen”, “blue sheen”, “silvery sheen”). The use of a Teflon® pad can dramatically increase the amount of oil sampled. The pad material should be Teflon® (or a similar inert polyfluoropolymer) because other materials interfere with the subsequent analytical processes in the chemical laboratory.

A practical arrangement for handling a pad is shown in the figures to the right. Great care must be taken during sampling to avoid contamination of the sheen by traces of oil from the sampling vessel or from other sources. The pad should be swept in the spill preferably until it is coloured by the oil. However, it should be emphasized that the pad may have absorbed a sufficient amount of oil even if the pad has no sign of brown colour.

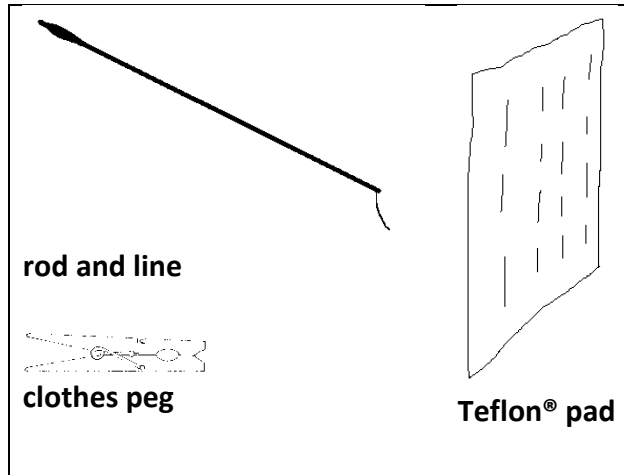

After a sufficient number of sweeps the Teflon® pad is carefully put into a sample bottle. The peg can be used to push the pad into the bottle. Another clean wooden peg of any kind can, if necessary, be used to assist in the procedure. It is important to avoid contact with any item that might contain traces of strange oils.

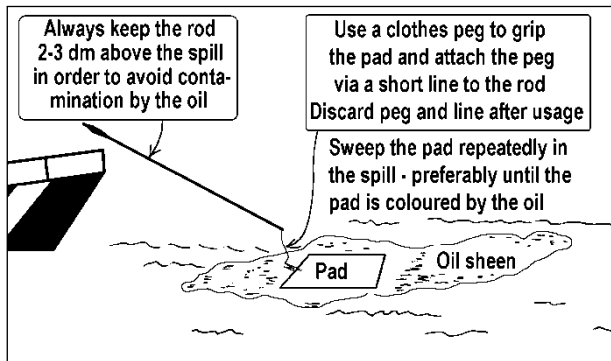

Teflon® pad on water surface

Taking oil samples on beaches and from oiled animals

3.5. Take samples in every continuous oil slick. In the case of a spill which is scattered over a long coastline many samples should be taken to enable a mapping of the oil distribution on the shores.

3.6. The oil should be scraped off oiled items and transferred into sample bottles. Avoid, if possible, contamination in the bottles by sand, grass and other debris. In exceptional cases when it is difficult to obtain clean oil samples, it is acceptable to place small oiled items (pebbles, small pieces of wood, etc.) in the bottles.

3.7. Any remaining traces on the shore from earlier oil spills must be carefully avoided during sampling a specific new spill. Take extra samples if there is any suspicion of more than one oil spill in the area (differing colour, consistency etc.). Always take blank samples in instances of hesitation. This is especially important when oil samples are scraped from creosote-impregnated wood.

3.8. Never take whole animal samples, body tissues etc. which may become rotten during shipment. Try to cut off small parts of oiled feathers, fur etc. Put the material directly into a sample bottle.

Use of sampling buoy from an airplane

3.9. It is possible to drop a sampling buoy into an oil spill from an aircraft. Attached to the buoy there is a Teflon® pad. Below are instructions on how such a sampling buoy should be handled when recovered from the surface of the sea.

1. Take a record of position, wind and sea currents.
2. Lift the buoy from the water **without touching the sample pad with fingers**.
3. Allow excess water to drain off from the sample pad. Check that the sample does not contain animal tissue which might rot during transport.
4. Insert the sample pad into a sample bottle. Pushing the pad with a clean peg of any kind can facilitate the insertion of a sample pad. Perform this **without touching with fingers** or contact with items that might contain disturbing contaminants.



The samples should be immediately transported to a sampling coordinator. Quick handling of samples is important. The samples should be kept below a temperature of +4°C.

More information concerning the sampling buoy can be provided by the Swedish Coast Guard.

Use of helicopter sampling device

Oil samples can also be taken from a helicopter. While different types of sampling devices are used for this purpose, they generally consist of a floating device acting as a counterweight to lower the sampling material itself (e.g. ETFE net) to the oil on the water surface and to assure contact between oil and sampling material. In this annex, equipment used by German Federal Police Department for Maritime Security and the Royal Danish Navy Command will be shortly described as examples (3.10-3.13). More information concerning the described methods can be provided by the authorities mentioned above.

Please note that there are other ways of taking samples from a helicopter³⁸.

3.10. Oil samples can be taken with equipment attached to a helicopter.



Example of a helicopter sampling device made from aluminum to which an ETFE net gets attached. The sampling device is kept ready for deployment with pre-cleaned ETFE net already attached, stored and transported in a sealed aluminum container (cylinder on the left pictures). Pictures left side: © BSH, Germany; picture right side: © Bundespolizei See, Germany

³⁸ Information of the procedures for airborne sampling can be obtained from the HELCOM Informal Working Group on Aerial Surveillance (IWGAS).



Right picture is another example of a helicopter sampling device set, using a floating device, nylon cylinder and ETFE net. The long white cylinder that is attached to the floatation device, has ETFE net attached on the inside with a Nylon strip. Top left image shows the set ready for sampling. Bottom left picture shows the ETFEE net inside the nylon cylinder. The Nylon cylinder with the ETFE net is removed from the floatation device after sampling, and packed for analysis.

3.11 ETFE nets deployed by help of a floating device will be transferred into clean sample glass bottles after being lifted back on board. Alternatively, the sampling device with the net still attached might be placed in special cases provided for transport to the laboratory for analysis.

3.12 Since sufficient cleaning of such sampling devices is not achievable in the field, several of these devices should be kept available on-site and a new sampling device must to be used per sample.

3.13. Some sampling devices may also be used for sampling from high embankments/ installations or from the sides of large ships.

4. INVESTIGATIONS AND OIL SAMPLING ON BOARD VESSELS

4.1. Samples must be taken on board ships observing appropriate caution in accordance with current safety regulations. During sampling on board ships the recommendations below in paragraphs 4.4 - 4.10 "General advice and directions for safety routines" should be followed carefully.

4.2. It is often difficult to obtain relevant oil samples on board suspected sources. Yet, it must be emphasized that it is of the utmost importance for an oil spill investigation that suspected sources of the spill are traced as far as possible and that reference samples are taken. Sometimes during sampling on board a vessel it is necessary to get assistance by the crew under control. However, it is quite wrong to accept unknown samples which are handed over by representatives from the ship or the shipping company.

4.3. Use a digital camera or a video camera to record observations which are judged to be valuable for the investigation.

General advice and directions for safety routines

4.4. Directions must be obtained from the ship's officers about how sampling should be performed in the light of the safety regulations current on board the ship. Sampling in tanks and spaces within the ship's hazardous areas should preferably be carried out by the ship's own crew. Sampling performed by the ship's crew should be strictly supervised by the personnel responsible for the sampling in order to avoid manipulation.

4.5. If the ship has its own sampling equipment, this should be used if possible. If this is not possible, sampling should be performed by means of external equipment only after approval by the ship's officers or by a ship-surveyor.

4.6. When samples are taken in tanks containing volatile petroleum products the following advice should be observed:

- a) Filter masks with a combination filter should be brought and used whenever necessary.
- b) The sampler should stand neither on the windward nor the leeward side of the hatch. A side wind gives the smallest risk of breathing gas.
- c) Only one hatch should be opened at a time.
- d) Avoid breathing petroleum gases, especially if they come from sour crude (smell of rotten eggs).
- e) One person should perform the sampling and another should supervise the sampler (safety guard). The latter should watch the sampler's condition in order to ensure that he/she is removed to a safe place if he/she is affected by petroleum gases (intoxication symptoms).
- f) Only explosion-proof equipment (marked EEx) should be used.
- g) The sampler should not have loose items in his/her pockets that could fall into the tank.

4.7. The following safety directions are based on the "International Safety Guide for Oil Tankers & Terminals" (ISGOTT):

During loading

4.8. Equipment made of metal for sampling and ullage-sounding must not be brought into the tank, or be left in the tank, during loading or within 30 minutes after loading has stopped. Examples of such equipment are steel measuring tapes and steel measuring sticks. Non-conducting equipment without metal parts may generally be used at any time. Cords, however, used for lowering equipment into tanks must be made of natural fibres (not synthetic materials).

After loading

4.9. Equipment made of metal for sampling and ullage-sounding can be used 30 minutes after loading has stopped. However, it is important that the equipment is firmly grounded to the ship's hull before it is brought into the tank. The equipment must remain grounded until after it has been removed from the tank.

Miscellaneous

4.10. Taking soundings and samples by means of pipes which are designed for this purpose is allowed at any time.

Sampling techniques

4.11. The following guidance is given on the taking of samples.

It may be difficult to obtain oil samples from tanks on board ships without opening manhole covers or drawing off pipes or pumps. However, it is often possible to use sounding pipes with a sample collector and glass tubes according to the adjacent figure. It is used with a steel measuring tape equipped with a carbine hook and a ground wire.

A clean, unused 10 ml glass tube is put into the sample collector which is hooked onto a steel measuring tape which must be grounded before starting the sampling. The oil sample is collected through a sounding pipe and transferred to a 100 ml sample bottle. The glass tube is discarded and the sample collector must be thoroughly cleaned!

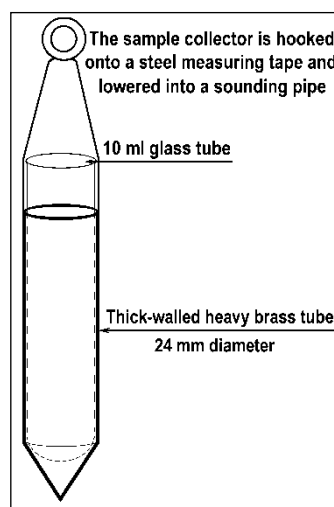

The bottom of the sample collector has the shape of a cone, which makes it lie down horizontally on the bottom of a tank. This makes it possible to get samples even from very shallow oil layers in a tank.

The sample collector and the steel measuring tape are reused and must therefore be cleaned off properly after usage. This is done by wiping them off with a cloth. Very small amounts of oil which cannot be wiped off will not contaminate the sample as long as the sample is proportionally much larger.



Sample collector with steel measuring tape



Left

The steel measuring tape must always be grounded to the ship's hull when oil samples are collected through a sounding pipe.



Right

The sample collector can also be used for taking samples from other places with difficult access in the machinery room.

If the oil sample is very small a Teflon[®] pad can be used. The pad is dipped into the sample and then absorbs a sufficient amount of oil. The whole pad is sent for analysis. The pad is made of Teflon[®] because other materials might contaminate the sample and disturb the succeeding analysis.

The Teflon[®] pad is very easy to use. However, the pad is much more sensitive to contaminations than the sample collector as the amount of oil in the pad is usually very small. The pad should therefore be used only when necessary and must be handled carefully so that it is not contaminated by other oils than the sample oil.

The Teflon[®] pad may well be attached to a cord and lowered down into machinery spaces which are difficult to reach.

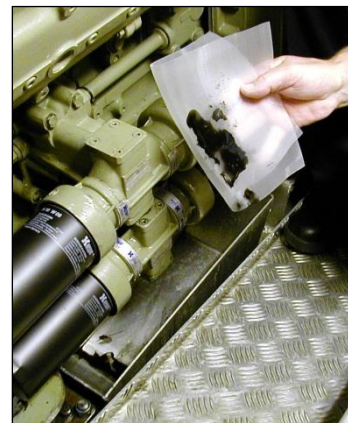

Teflon[®] pad

Checklist for sampling in cargo oil systems

4.12. The following is a checklist for sampling in cargo oil systems:

- a) Find out the ship's category according to the MARPOL Convention (COW, SBT, CBT or standard ballasted tanker below 40,000 tdw). Make a copy of the IOPP certificate.
- b) Note the ship's state of loading (cargo/ballast) and make a copy of the Bill of Lading for the current (latest) cargo voyage.
- c) Check the Oil Record Book concerning the whole cycle loading-unloading-ballasting-tank washing. Check that it is signed by the Master. Make a copy of the pages which may be of current interest.
- d) If possible, get hold of a copy of a drawing of the ship's piping system for loading and ballasting.
- e) Check the printouts from the oil-content meter and make a copy of the printout for the current voyage.
- f) Verify current state of ballast (or loading) and check ballasted tanks as well as tanks ballasted during earlier part of voyage.
- g) Check the ship's status in the cargo/ballast cycle, i.e. whether the ship carries departure ballast or arrival ballast, whether tank cleaning has been performed and whether collecting tanks (slop tanks) have been emptied.
- h) Document all oil samples carefully by means of sample bottle labels. Take samples of all oil types which the ship has carried recently and of all oil mixtures which may have been created on board the ship. Take samples of oil residues from all possible sites.
- i) Observe the following:
 - i. The ship's own reference oil samples
 - ii. Slop tanks (also oil-water interface levels, slop volume and water volume)
 - iii. Tanks which contain or have contained oily ballast
 - iv. Pump room keel
 - v. Stripping pumps
 - vi. Overboard piping (both sides)
 - vii. Ballast discharge piping (both sides)
 - viii. Cargo manifolds on deck
- j) Check the records of the Oil Discharge Monitoring System. Oil tankers have an Oil Discharge Monitoring System (ODMS). The ODMS is fitted with a recording device to provide a continuous record of the discharge in litres per nautical mile and the total quantity discharged or the oil content and rate of discharge.
- k) Note other observations that may be of value for making a judgement about possible discharges. Take photos of sample sites and other places that may be of value for the investigation.

Piping system of an oil tanker

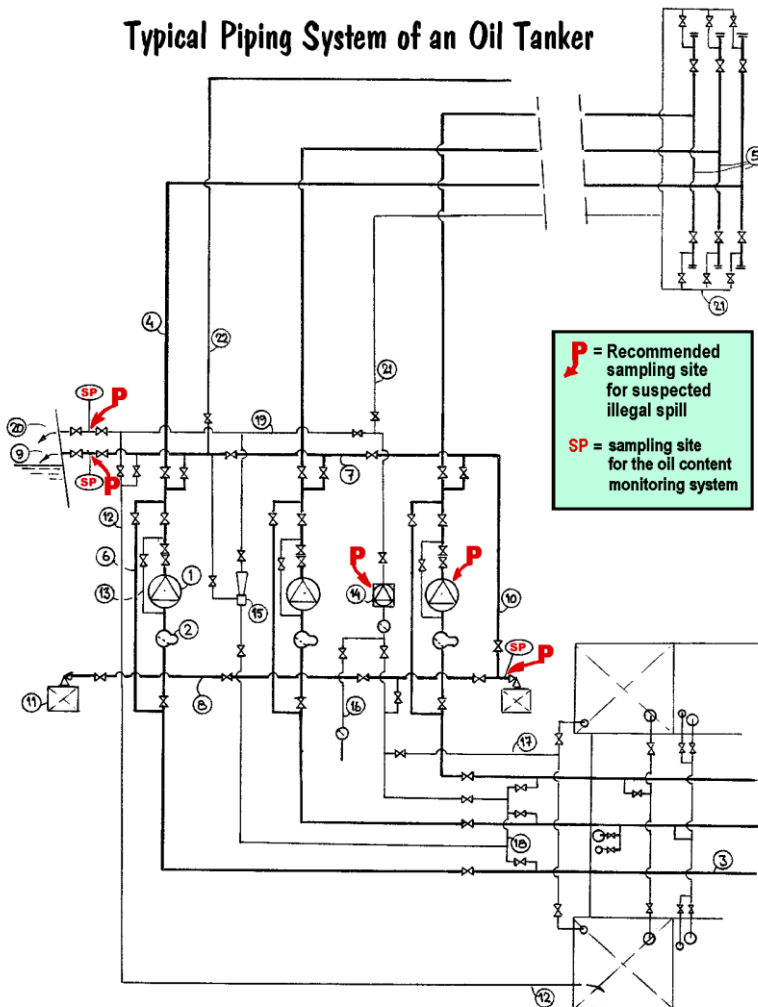

Legend for the above figure

1. Cargo oil pump, usual centrifugal type, 2-4 pcs
2. Pump mudbox, often combined with a vacuum tank for pump evacuation
3. Cargo oil piping in cargo tanks with branchings and connections to the cargo tanks
4. Pump riser to deck and piping on deck
5. Manifold with land connections
6. Pump shunts that allow loading through the piping system (these are sometimes arranged directly from the deck pipes to the bottom pipes, so called "drop lines")
7. Cross-over at the pumps' pressure side, simultaneous connection overboard (sometimes separate pipes)
8. Pipe at the pumps' suction side with connection to sea valves
9. Discharge overboard from the pumps' connection pipe at the pressure side
10. Ballast pump pipe from the pumps pressure side to sea valve. (This is an earlier alternative to discharge according to 9, and in such case arranged at both sides. The alternative according to 9 is required on new ships. Arrangements according to both 9 and 10 do not exist at the same time.)
11. Sea inlet, usually from both sides
12. Return pipe from overboard connection to slop tank
13. Shunt for drainage of cargo pipes to the suction side of the system
14. Stripping pump, usually plunger type, 1-3 pcs
15. Stripping ejector, 1-3 pcs, sometimes none
16. Suction pipe from the pump room keel
17. Stripping pump's direct suction from slop tanks

18. Stripping suction pipe from the cargo oil piping
19. Stripping system's connection pipe at the pressure side with overboard pipe
20. Stripping system's overboard outlet (may be combined with 9)
21. Stripping pump's pipe for drainage to land
22. Feeding to the tank washing system

Sampling in machinery spaces

4.13. The following is a checklist for sampling in machinery spaces:

- a) Check whether the ship has IOPP certificate, and note whether the ship is certified for 100 ppm or 15 ppm separator standard. Note also whether the ship is exempted from any requirement regarding equipment. Make a copy of the certificate.
- b) Study the Oil Record Book for the engine room and copy the pages for the last 30 days
- c) Figures in the engine logbook should be in agreement with the figures in the oil record book.
- d) Check all levels and contents, and take samples of the following:
 - i. Bilge sump
 - ii. Bilge water tank (note down a remark if it does not exist)
 - iii. Waste oil tank (may be more than one)
 - iv. Repletion tank connected to oil fuel tanks
 - v. Separator sludge tanks
 - vi. Empty bunker tanks used for ballast water
- e) Take samples also from:
 - i. Fuel day tanks
 - ii. Bilge water separator outlet
 - iii. Sludge pump outlet

4.14. In addition, the sampler should be aware that oil from the engine room may have been discharged by the emergency bilge pump. This is usually done by an ejector driven by the fire pump or a sea water pump which can also be used as a bilge pump. If there is any suspicion of this:

- a) Examine the bilge water separator. Check the liquid in the plug cock and (if there is any suspicion) insist that the filtering unit is opened.
- b) Examine the tank top for sludge.
- c) Make notes of the types of cleaning agents used in the engine room as well as the stated consumption of them.
- d) If the ship is larger than 10,000 GT and has a 15 ppm separator, the oil content meter and its printout should be examined. Make a copy of the printout for the current time.
- e) Make notes of other observations that are relevant for making a judgement about possible discharges. Take photos of sampling sites and other places which may be relevant for the investigation.

Basic oil handling systems

4.15. The following diagram shows the basic oil handling system of a well-equipped modern ship, a common ship and ships smaller than 400 GT:

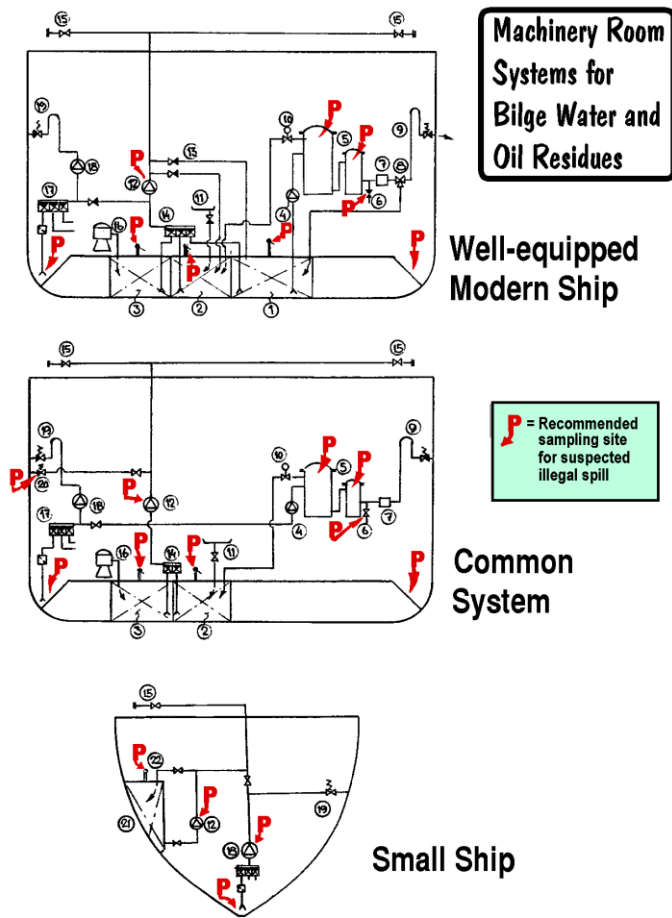

Legend for the above figure

1. Bilge water tank
2. Waste oil tank
3. Sludge tank
4. Bilge water pump/feed water pump to bilge water separator
5. Bilge water separator, 100 ppm or 15 ppm standard
6. Sampling tap in separator outlet
7. Monitoring instrument for high oil content in separator outlet (compulsory on some occasions only)
8. Three-way valve for returned cleaned bilge water
9. Overboard pipe from bilge water separator
10. Automatic drainage of oil from bilge water separator
11. Oil sump under drainage sites
12. Transfer pump for sludge and oil residues to deck. This pump can also be used for transferring bilge water from bilge sumps to bilge water tank.
13. Transfer pipe for bilge water from bilge sumps to bilge water tank
14. Suction pipes from tanks for transfer to deck
15. International land connection on deck
16. Centrifugal separators for fuel oil and lubrication oil
17. Suction pipe from bilge sumps
18. Main bilge pump which may be used in emergency situations only, and for draining bilge water from the keel to bilge water tank
19. Overboard pipe from main bilge water pump (should be locked in closed position, however not compulsory)
20. Overboard pipe from sludge transfer pump (improper arrangement but not forbidden)

- 21. Collection tank for all types of dirty water
- 22. Transfer pipe for dirty water to collection tank

Taking soundings of ullage and oil-water interface levels

4.16. In some investigations there is a need to calculate the oil volume in a tank where water has penetrated. This can be done by gauging or sounding the tank's ullage and oil-water interface level (see the figure below).

4.17. Ullage and interface gauging are done in cargo and bunker tanks. Taking soundings is the most common method for ballast and fresh water tanks, cofferdams etc. Whether a given tank gauge figure is an ullage or a sounding value can be checked in the ship's tank tables.

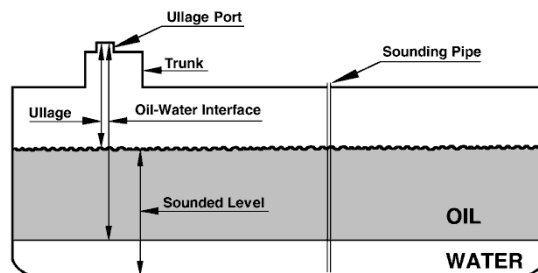

4.18. All gauging must be performed according to the safety advice and directions given in paragraphs 5.4 - 5.10 above.

4.19. Gauging should preferably be carried out by the ship's own crew using the ship's own equipment, under supervision of the personnel responsible for the operation.

4.20. Taking soundings of interface level and ullage is normally done by means of a steel measuring tape equipped with a ground wire. The steel measuring tape must be grounded by way of connecting the grounding wire to the ship's hull. Before a sounding pipe or a manhole is opened, it is important to check that the cable clamp is safely contacted to the hull, if necessary by scraping off paint, rust etc. There is no risk of sparks from static electricity if the steel tape is electrically connected to the ship's hull.



4.21. What is called "**water-finding paste**" may well be used on a normal steel measuring tape to sound the oil-water interface level. The tape is coated with this paste which turns red upon contact

with water. The interface level can then be read on the tape. Alternatively, the steel tape can be chalked with ordinary blackboard chalk. On some occasions the contrast between oil and water on the steel tape will be better with chalk than with water-finding paste.

4.22. The level of the oil-water interface level can also be established by a special **oil-water interface meter** which may consist of a steel measuring tape with a probe in one end and a handle, with an indicator, in the other end. The indicator gives a response for the conductivity of the medium into which the probe is immersed. When the probe is immersed only in the oil, the conductivity is rather low, but when the probe reaches the water interface the conductivity increases considerably. At this point, the probe's (and thus the interface's) distance from the handle can be read on the steel tape.

5. HANDLING SAMPLES

Sample custody and documentation

Samples and sampling equipment should be handled and stored so that the samples cannot be manipulated, mixed up or otherwise be contaminated by strange oils. Samples should be handled as legal evidence and should be kept in a "chain of custody" until identification and possible legal procedure has been completed. Therefore, always use approved sealable and individually numbered safety bags with three detachable adhesive number labels with identical number (the same as on the bag).

Each safety bag number is unique for one specific sample. The number is the identification of the sample. One of the detachable number labels shall be affixed onto the glass sample bottle. The next number label shall be placed on the outer plastic jar and the third label on the Letter of Request (described below).

A sample label (see below for an example) shall be affixed to each sample bottle.



<i>(Space for a number label from an individually numbered safety bag)</i>		Sampling date:
		Judged date for spill:
		Sampling site:
<input type="checkbox"/> Spill	<input type="checkbox"/> Ref. sample (e.g. from a ship)	Suspected source:
TEMP. °C Water:	Air :	Spill information (volume, extension, judged oil type etc.)
SAMP- Name:	Field unit:	
LER Phone: _____	Alt. phone: _____	

Important documentation for the taking and shipping of oil samples

- **A letter of Request** with a specification of the request and information on enclosed samples (see 6. Request for Analysis). Necessary information in the Letter of Request and/or in the sample bottle label is the following:
 - o District, sampler, unit
 - o Date and position (or sampling site on board vessel) of sampling
 - o Spill's volume/appearance, oil type
 - o Suspected source
- **Sample labels** shall be affixed onto all sample bottles.
- **Number labels** from individually numbered safety bags shall be affixed onto all sample bottles.

Filling and labelling of sample bottles

1. As sample containers use 100 - 250 ml thick-walled wide-neck borosilicate glass bottles. A suitable inner neck diameter is 30 mm. The lid tightening should be of high quality. Use a new (unused) sample bottle for each sampling site.
2. If possible, avoid getting water into the bottle. One method to remove water from the bottle is to close the lid and hold the bottle upside down for a minute. Then let the oil float upwards to the bottom of the bottle so that the water can be drained by opening the lid carefully.
3. Do not fill the bottle to a higher level than to 2 cm below the lower edge of the lid. If the bottle is completely filled of cold oil it may later leak when the oil volume increases at room temperature.
4. Check that the bottle lid gasket is undamaged and that the lid fits tightly. Carefully wipe excess oil and water from the outside of the bottle.
5. Affix a filled-in sample label onto each bottle.

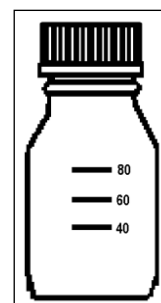

Packing of samples

1. An oil sample must be packed appropriately before it can be shipped to a laboratory for analysis. The sample is usually in either of the following forms:
 - free oil
 - sample pad containing oil
 - oiled item (feather, piece of wood, stone etc.).
2. Allow excess water to drain off from the sample. Check that the sample does not contain animal tissue which might rot during transport. Insert the sample into a sample bottle. The insertion of a sample pad can be facilitated by pushing the pad with the used clothes peg or a clean peg of any kind. Perform this without touching with fingers or contact with items that might contain disturbing contaminants.
3. Affix a sample label onto the sample bottle and a number label from an individually numbered safety bag.

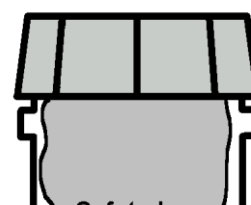

4. Insert the bottle into a safety bag and seal the bag according to the bag's instruction.
5. Put the bottle package into a 600 ml plastic jar which is used as an outer container. Affix the second number label onto the outside of this jar (keep the third number label for the Letter of Request).
6. The samples should be immediately sent to the Sample Coordinator. A quick handling of samples is important. If the transmittal is delayed the samples should be kept under a temperature of less than +4°C. The Sample Coordinator watches the continued shipping of the samples.
7. The plastic jar (with its content of a sample bottle in a sealed safety bag) should be placed in a cardboard box, before shipment, as shown in the figure to the right. If prescribed in local regulations the whole packaging must be approved and the cardboard box must wear an inscription which shows this approval (see the example under the cardboard box).

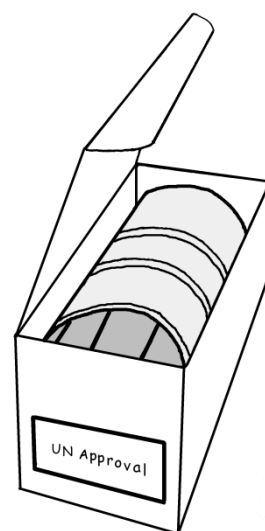

Shipping of oil samples

The Sample Coordinator collects all samples and fills in a Letter of Request which is sent to the laboratory together with the samples.

The Sample Coordinator should also call in special personnel if required from an Industrial Laboratory for conducting physical analyzes. The purpose is to take samples on board a ship to investigate if an oil is persistent according to the specifications of the International Oil Pollution Compensation Funds. The Sample Coordinator judges if it is more appropriate for the local samplers to perform this work. In this case the Sample Coordinator acquires special sample containers from the Industrial Laboratory.

Oil samples are to be considered as dangerous goods when they are shipped. However, if contained and packaged as described above, they can normally be shipped as "limited quantities" which means simpler shipping requirements than for normal dangerous goods. **Local regulations should always be followed.**

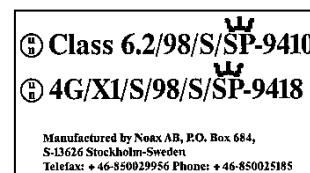

Examples of sampling kits

Case with equipment for sampling of oil spills	No.
Metal ring (for polyethylene cornet)	1
Holder for metal ring	1

Polyethylene cornet	20
Teflon® pad (20x30 cm) for thin oil films	15
Peg (for Teflon® pad)	20
Line (for rod and peg)	coil
Rod (for Teflon® pad) (perhaps not enough room in the case for this rod)	1
Sample bottle, 100 ml thick-walled borosilicate glass	10
Sample label	50
Safety bag (20x30 cm), approved, sealable, individually numbered	50
Wiping cloth (or paper)	package
Disposable gloves	package
Sampling peg (for scraping small samples of oil)	50
Plastic bag (for filled sample bottles, garbage etc.)	20
Laminated oil sampling flow diagram	1
Laminated instruction "Oil spill sampling"	1
Laminated equipment list	1



Case with equipment for sampling on board ships	No.
Sample collector of brass for sounding pipes (to be hooked on the steel measuring tape)	1
Steel measuring tape	1
Brass weight (to be hooked on the steel measuring tape)	1
Ground wire (to be hooked on the steel measuring tape)	1
Water finding paste	tube
Blackboard chalks (for chalking steel measuring tapes)	package
Glass tube 10 ml (with lid) for sample collector	10
Teflon® pad (20x30 cm) for thin oil films	15
Line	coil
Sample bottle, 100 ml thick-walled borosilicate glass	20
Sample label	50
Safety bag (20x30 cm), approved, sealable, individually numbered	50
Writing-pad (with cover and pen)	1

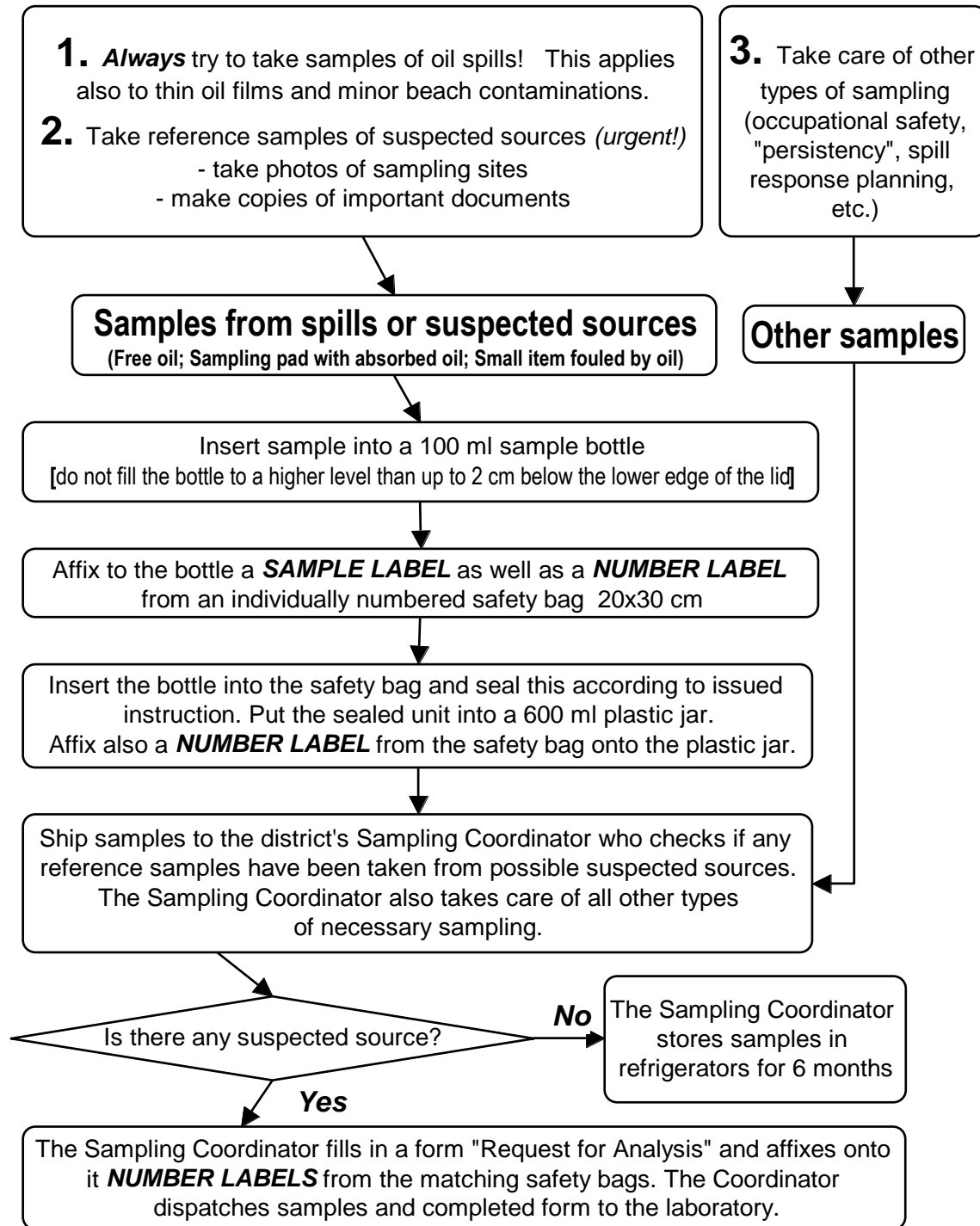

6. REQUEST FOR ANALYSIS (example only)

Sending Unit

Date

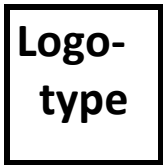

Commanding Officer

To: *Laboratory name and address*

Request for analysis

Request analysis of the samples listed below

Sampling date:

No. of samples:

No. of pages:

General information (Occurred incident, weather, spill size, suspected source, judged oil type etc.)	Number label from safety bag	Information which is not given on the sample bottle *

*Information: Sampler: Name/field unit
 Spill: Latitude & longitude and sampling site's geographical name
 Ship: Ship name and sample site on board the ship

 Signature

 Name in block letters

 Rank

7. CHECKLISTS FOR OIL SAMPLING

General

1. Samples should be taken with sampling devices and containers of glass, Teflon[®] or stainless steel. Use disposable devices if possible and make sure they are used only once.
2. Preferably, at least 1 ml of oil should be sampled but no sample should be considered too small. If possible, a larger sample volume is recommended for additional analyzes (100 ml).
3. If contamination of the sample is suspected, take blind samples from the possible contamination.
4. To permit cross-checking, three parallel samples should be taken from some of the localities. In larger spills, one sample per locality should be sufficient.
5. The sampling container should be properly labelled with all relevant information before sealing of the safety bag.
6. A sampling logbook with all relevant information from the samples and the sampling environment should be kept.
7. The samples should be taken and handled under the supervision of authorized personnel. A chain of custody should be maintained until the identification process is concluded by the relevant authority.
8. If stored, all oil samples should be kept under lock and key in darkness at a maximum temperature of +4°C (but not be frozen).
9. Oil samples should be taken to an authorized laboratory without unnecessary delay.
10. Packing and transport should be carried out in such a way that damage to the samples is avoided. Sorbent material should be used.
11. National regulations for transport of flammable materials should be followed.
13. Samples should be handled as legal evidence.

Collection of samples from the water surface

1. Try to concentrate the oil fraction in the sample container by skimming the oil from the water. A conical Teflon[®] bag, polyethylene cornet or a clean bucket with small holes can be used to concentrate the oil into the container.
2. Do not fill the container completely. Allow for thermal expansion of the sample.
3. If possible, sample oil from the thickest part of the slick.
4. In highly contaminated waters, e.g. harbours, take blind samples.
5. If a combat action against a waterborne oil spill lasts for several days, take oil samples every day for documentation of weathering and possible additional spills from other sources.
6. If other suspicious slicks occur, i.e. their appearance differs, or if slicks are observed a long distance away from the expected site, also take samples here for identification of other possible sources.

Collection of samples from beaches

1. Take samples from the geographical edges of the polluted area to document the range of the spill.
2. Take samples from different localities within the polluted area to document the spill distribution.
3. Old tar balls, earlier oil spills, creosote from pier logs etc. can contaminate the sample. Take blind samples if contamination is suspected.
4. Take samples for identification of other possible sources whenever anything unusual or suspicious (colour, texture etc.) is observed in the polluted area.
5. When seaweed, small pieces of wood or debris are contaminated by oil, the complete specimen can be placed in the sampling container.

Obtaining samples from oiled animals

1. Contaminated feathers and fur may be cut off and placed in the sample container.
2. Dead, oiled birds or other animals may be collected in plastic bags, labelled and frozen before sending to a laboratory.
3. Before sending any animals, make contact with the relevant authority to make proper arrangements for transport and storage.
4. Samples with large amounts of organic materials should be frozen to avoid biological decomposition.

8. OIL SAMPLING ORGANIZATION

Background

8.1. A whole chain of activities leads to the information to be presented about a certain spill. Sampling is the first step in the process of obtaining information about the spill. If the sampling is not done in a proper way the results of the analysis will not be as accurate as possible.

8.2. Samples can be taken from the water surface, suspected polluter or the shoreline. It is important to take samples as often as possible. One reason is that the personnel will keep up their know-how. Another reason is that even if there is no suspected polluter when an oil spill is observed one might be identified at a later stage.

8.3. This document presents the purpose of sampling and how sampling activities can be organized.

Training

8.4. All personnel involved in sampling need to be trained to assure the sampling is performed in a correct way. This is also something that will be questioned by lawyers in the legal process following an oil spill. When samples are taken at a suspected polluter it is important that the sampler has been

working on board ships. This will make sure he/she will have the knowledge and experience of the piping systems in machinery spaces and cargo systems.

8.5. Training should be ongoing to ensure that the level of competence is maintained over time.

Purpose of sampling

8.6. Sampling and subsequent analysis shall answer questions regarding the spills' origin as well as their properties and effects. To accomplish this, samples should be taken for several different purposes, which are dealt with in this section.

8.7. Some spills may involve contacts and coordination with other countries regarding sampling and analysis. On some occasions, the International Oil Pollution Compensation Funds in London needs supplementary information. Occasionally, foreign agencies should be contacted to exchange samples, analysis results, examination reports etc.

Occupational safety

8.8. When necessary, the spill should be examined (analyzed) to establish whether there are any health risks for the response personnel. The substance may be flammable and cause fire and/or explosion, or may be toxic and cause danger to health if inhaled or exposed to skin.

Penal liability of the polluter

8.9. The responsible polluter should, if possible, be identified and be charged for the spill. This can be done by comparing chemical analyzes of samples from the spill with samples from suspected sources. If identity is established between the spill and a suspected source, this can help to identify the polluter.

Economic liability of the polluter

8.10. The results of sampling have often been used as a basis for compensation claims against the polluter. These claims may concern costs associated with response and clean-up measures, or damage to property, fishery, recreational areas etc. Above all, it is important to tie the suspected polluter to the damage in order to confirm the claims. Supplementary analyzes are sometimes needed to show if the oil has such properties ("is persistent") so that compensation can be obtained from the International Oil Pollution Compensation Funds in London.

Spill response planning

8.11. On some occasions, special analyzes can give important support information for the planning of response and clean-up work. It is important to study chemical and physical property data of the substance when selecting equipment and methods as well as safety routines for the response operation.

Short term environmental protection

8.12. The substance's acute deleterious effects on the environment may vary considerably depending on its properties. Extremely viscous oils have lower tendency to smear beaches, plants and animals. Medium viscous oils create high risk for smearing. Low viscous oils give low risk for smearing, but

dissolve greater amounts of dangerous components into the water body. Besides the substance itself it may also be necessary to sample and analyze the water column, sediment, organisms etc.

Long term environmental protection

8.13. Certain substances may cause long-term deleterious effects on the environment, and some species may be knocked out, or the environment be polluted for a long time. Assessment should be made to judge how the environment can be restored. It may be necessary to sample and analyze the substance itself, as well as water, sediment, organisms etc.

Information service

8.14. Many, and sometimes tricky, questions are asked about the substance's properties and effects, especially when facing a large or hazardous spillage. In such cases it is important to give rapid and correct information in order to reduce public concern and the spread of rumours. Sampling and analysis can thereby provide the basis for information to be given and for the choice of information channels. When informing the public, and those who are directly affected by the spill, it is important to account for certain data, for example:

- the spill's origin and extension
- the substance's properties and spread in the environment
- effects on human and environment
- consequences for various parties and bodies
- ongoing work regarding response, clean-up and disposal.

Disposal

8.15. The selection of techniques for the subsequent disposal is based on the spill's volume and its properties. For instance, certain disposal plants cannot process oils with a water content which is too high. Others cannot process oils which contain too much debris. Certain oils may contain toxic (for example chloroorganic) compounds. Such impurities may put heavy demands on the disposal process technique. On such occasions, a special examination is needed to establish the oil's properties and impurities.

Summary of purpose and types of samples

8.16. The table below summarizes the various purposes of sampling, and types of samples that may be necessary to take during major spills of oil and hazardous materials at sea. The table also states by whom the various types of samples should be taken.

PURPOSE	SAMPLES (examples)	SAMPLER (examples)	SAMPLE USER (examples)
1. Occupational safety	Air samples taken with trace gas detection devices	Coastguard Municipality	Response Commander
2. Penal liability of polluter	Several samples (0.1-100 ml), taken with the Coastguard oil sampling kit, both from spills and suspected sources	Coastguard Shipping Administration Police Municipality	Coastguard Police Prosecutor
3. Economic liability of polluter	Samples according to 2; Also extra samples (at least 100 ml) for examination of "persistency"; Biological samples	Coastguard Municipality Local government	Insurance company International Oil Pollution Compensation Funds Central government Rescue Services Agency
4. Spill response planning	Samples according to 2; Also extra samples (at least 100 ml) for examination of viscosity, density etc.	Coastguard Municipality	Coastguard Municipality Local government
5. Short-term environmental protection	Samples from spill, water body, sediment, organisms etc., for chemical-biological analyzes	Local government Municipality	Municipality Local government Environmental Protection Agency Fisheries Management Agency
6. Long-term environmental protection	Samples according to 5	Municipality Local government Environmental Protection Agency Fisheries Management Agency	Municipality Local government Environmental Protection Agency Fisheries Management Agency
7. Information service	Samples according to 2; Also extra samples (at least 100 ml) for special analyzes	Coastguard Municipality Local government Environmental Protection Agency Board of Fisheries	Authorities Mass media Public Fishermen Scientists
8. Disposal	Sample (1 litre) for examination of water content, debris etc., that can effect the disposal process	Coastguard Municipality	Local government Municipality Transport business Disposal and recycling plants

Responsibilities during sampling

8.17. Spills of oil and hazardous materials occur every day in the marine environment as well as in the inland aquatic environment. Although most of the spills are very small, they still often require sampling to get a chance of linking them to the responsible polluters and assessing the damage to environment. It is therefore important to trace all conceivable polluters as soon as possible. There is a great need for coordination as the sampling activities for spills and suspected sources may go on simultaneously at different places. This work may be performed by a **permanent Sampling Coordinator** within the environmental response organization. This Coordinator should be subordinated to the District Chief of the Environmental Response Organization. During the Organization's everyday work the Sampling Coordinator keeps record of spill samples from various sites and initiates sampling on board suspected sources when overlooked by the field officers.

8.18. The sampling activities may increase considerably during more significant accidents involving spills of oil and hazardous materials. Many different samples are taken for several different purposes. Many authorities and institutions may be involved in the sampling activities and a confusing situation may arise where different bodies work, perhaps without being aware of each other. On such occasions, it is crucial to coordinate the activities to avoid duplication of work, as well as to avoid missing chances of important sampling. Such coordination could also promote prevention of public concern and the spread of rumours that often occur during major and hazardous spill accidents. In this situation, the Environmental Response Commander should appoint an **ad hoc Sampling Coordinator** to be responsible for the overall coordination of all sampling work during the course of the response operation.

8.19. Whenever there is co-operation in a major spill accident between two or more different national response services, an agreement should be settled on a joint ad hoc Sampling Coordinator. He/she should be responsible for the overall coordination of all sampling on land and at sea during the run of the response operation. When the accident response phase is finished, and the long-term clean-up work has started, the responsibility for sampling is normally handed over to the local Municipality. However, it is convenient that the original ad hoc Sampling Coordinator maintains the duty for sampling concerning the polluter's penal and economic liabilities.

8.20. The contact network for the Sampling Coordinator and other bodies is shown in the following chart.

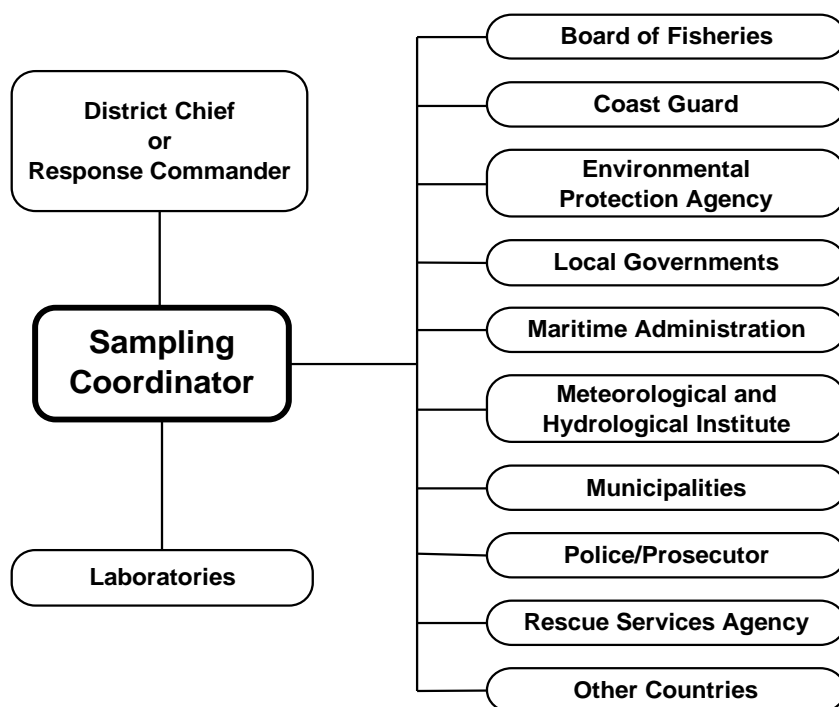

Duties of the Sampling Coordinator

8.21. The Sampling Coordinator, following the above tables, should:

- a. Establish a plan for documentation of the sampling work.
- b. Make arrangements for appropriate sampling if health risks are liable to occur.
- c. Make sure that necessary samples are taken concerning extent and accuracy both of spill, contaminated items and suspected sources.
- d. Judge whether the oil has such properties (“is persistent”) that compensation can be obtained from the International Oil Pollution Compensation Funds in London. In such a case, provide for appropriate sampling and analysis.
- e. Judge whether special examinations of the spill are needed to facilitate spill response measures.
- f. Judge whether short-term and/or long-term environmental impact may be expected. In such a case, contact appropriate agencies according to the table in Section 3.10.
- g. Judge whether special examinations and analyzes are needed when providing for general and specific needs for information.
- h. Contact responsible bodies for transport and disposal. Check what special information is needed in this context and make arrangements for relevant analyzes.

Handling of spill information

8.22. A whole chain of activities lead to the information to be presented about the spill. This chain consists of:

- a. Sampling
- b. Sample keeping and transmittal
- c. Identification, labelling, documentation
- d. Chemical, physical and biological analyzes
- e. Judgement of the analysis results
- f. Presentation of the analysis results

8.23. Each step must be taken with care and accuracy. This is a prerequisite for compilation of an information report which is as comprehensive, clear and effective as the circumstances allow. Examples of points to be observed during sampling and the subsequent handling of samples are:

- a. Several samples must be taken from spills which cover large areas or which are divided between several locations.
- b. Use as much disposable equipment as possible to minimize the potential of contamination.
- c. Sampling from a source which is suspected of being responsible must be performed very carefully, so that the suspected polluter can be tied to the spill with certainty, or cleared of responsibility.
- d. All samples must be labelled so that they unmistakably refer to the correct sampling points.
- e. Sample containers must be labelled, sealed and kept in such a way that any suspicion of confusion or manipulation can be excluded.
- f. All sampling documentation, as well as other evidence, must be available throughout the investigation, but must also be protected from loss, confusion or manipulation.
- g. Records must be kept continuously and contemporaneously of all transmissions between officials of samples, other evidence and documentation.

8.24. The Sampling Coordinator is responsible for transmission of samples to the appointed laboratories.

8.25. It is recommended that laboratories which will be used for the analysis are contacted prior to any oil spill to make sure templates for request for analysis are available and to establish channels for contact in case quick analyzes are necessary.

8.26. It is important that a complete chain of custody is maintained. The samples should be kept under control from the initial sampling until the legal process is finalized.