

Guidelines for Harmonizing Ocean Surface Microplastic Monitoring Methods

Version 1.2, May 2023

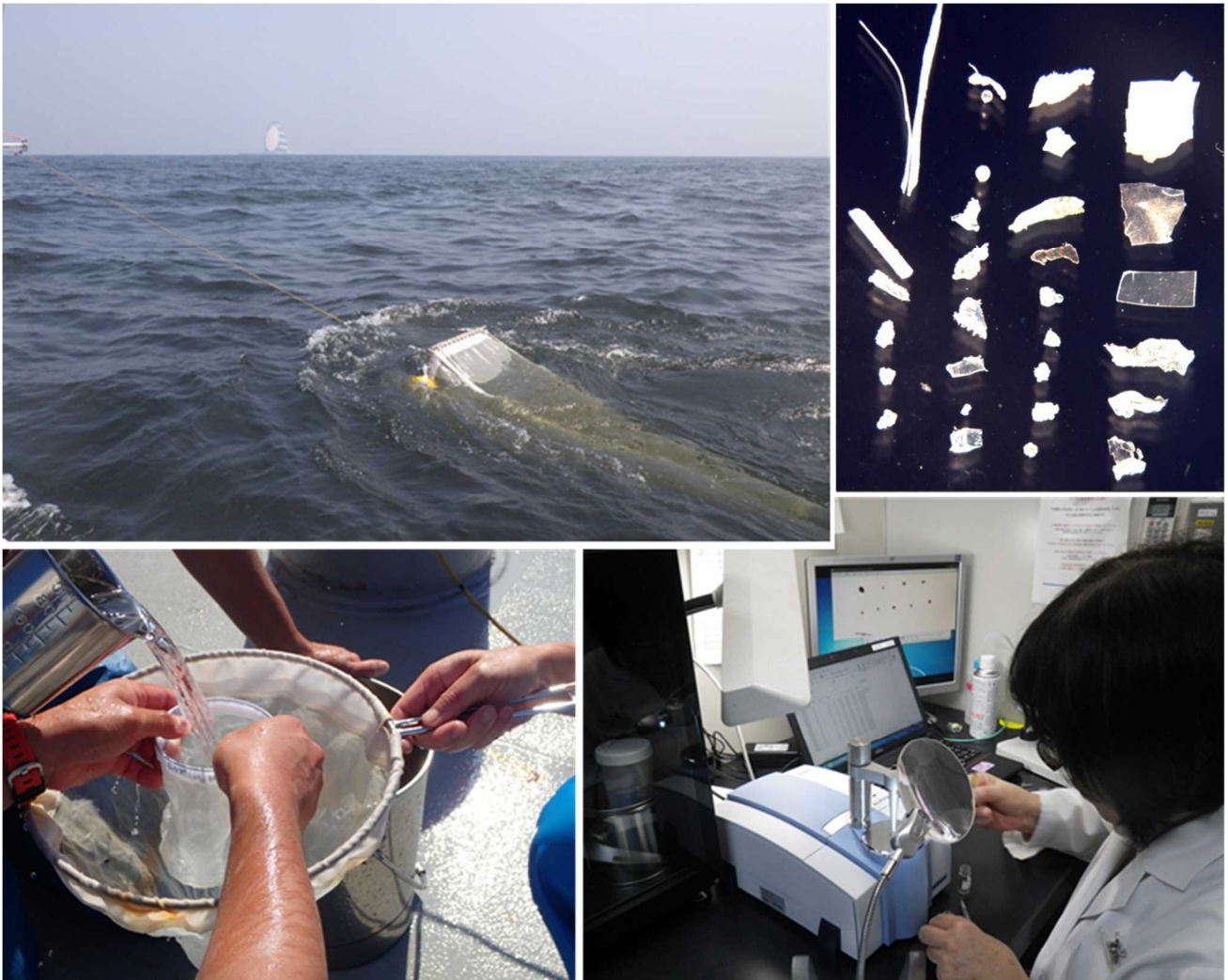

Ministry of the Environment, JAPAN
May 2023

Guidelines for Harmonizing Ocean Surface Microplastic Monitoring Methods

MICHIDA Yutaka ¹, CHAVANICH Suchana ², CHIBA Sanae³, CORDOVA Muhammad Reza⁴,
CÓZAR CABAÑAS Andrés ⁵, GALGANI Francois ⁶, HAGMANN Pascal ⁷, HINATA Hirofumi ⁸,
ISOBE Atsuhiko ⁹, KERSHAW Peter ¹⁰, KOZLOVSKII Nikolai ¹¹, LI Daoji ¹², LUSHER Amy L. ¹³,
MARTÍ Elisa ⁵, MASON Sherri A. ¹⁴, MU Jingli ¹⁵, SAITO Hiroaki ¹, SHIM Won Joon ¹⁶, SYAKTI
Agung Dhamar ¹⁷, TAKADA Hideshige ¹⁸, THOMPSON Richard ¹⁹, TOKAI Tadashi ²⁰, UCHIDA
Keiichi ²⁰, VASILENKO Katerina ²¹, WANG Juying ¹⁵,

¹ The University of Tokyo, Japan

² Chulalongkorn University, Thailand

³ Japan Agency for Marine-Earth Science and Technology, Japan (Current position: North Pacific Marine Science Organization (PICES))

⁴ The Indonesian National Research and Innovation Agency (BRIN), Indonesia

⁵ University of Cádiz, Spain

⁶ IFREMER (French Research Institute for Exploitation of the Sea), France

⁷ Association Oceaneye, Switzerland

⁸ Ehime University, Japan

⁹ Kyushu University, Japan

¹⁰ Independent consultant - marine environmental protection, United Kingdom
(Chair, GESAMP WG40)

¹¹ Pacific Geographical Institute, Russia

¹² East China Normal University, China

¹³ Norwegian Institute for Water Research, NIVA, Norway

¹⁴ The Pennsylvania State University, Behrend College, USA

¹⁵ National Marine Environmental Monitoring Center, MEE, China

¹⁶ Korea Institute of Ocean Science and Technology, Korea

¹⁷ Raja Ali Haji Maritime University (UMRAH), Indonesia

¹⁸ Tokyo University of Agriculture and Technology, Japan

¹⁹ University of Plymouth, United Kingdom

²⁰ Tokyo University of Marine Science and Technology, Japan

²¹ Vancouver Aquarium Marine Science Centre, Canada

The suggested citation for this document is:

Michida, Y., et al. (2019). Guidelines for Harmonizing Ocean Surface Microplastic Monitoring Methods. Ministry of the Environment Japan, 74 pp.

For copies of this document, please contact:

Office of Policies against Marine Plastics Pollution, Water Environment Division,
Environmental Management Bureau, Ministry of the Environment, JAPAN
Kasumigaseki 1-2-2, Chiyoda-ku, Tokyo 100-8975, Japan

Acknowledgements

The contributions and cooperation of the following laboratories were extremely important and essential to the preparation of these Guidelines, both in analyzing standard microplastic samples prepared for experimental analysis, and reporting the results of their analyses to clarify the differences between analytical methods and practices.

Thank you to the participation of Association Oceaneye, Chulalongkorn University, Ehime University, Korea Institute of Ocean Science and Technology, Kyushu University, Norwegian Institute for Water Research, National Marine Environmental Monitoring Center, MEE, National Oceanic and Atmospheric Administration, Pacific Institute of Geography, Tokyo University of Marine Science and Technology, University of Cadiz, and Vancouver Aquarium Marine Science Centre.

Special thanks are noted to DELORENZO Marie, BUENAVENTURA Nina T., ROSS Peter S., CHASTAIN Stephen, VIYAKARN Voranop, and ZHANG Weiwei for their contributions to the inter-laboratory comparison in 2017 (ILC).

Preface:

This document presents the version (1.2) of “*Guidelines for Harmonizing Ocean Surface Microplastic Monitoring Methods*” (herein after referred to as the Guidelines). Its primary goal is to propose ways of harmonizing methodologies for monitoring microplastic densities at the ocean surface to deliver comparable results. Specifically, the Guidelines indicate the rationale for various sample collection methods, sample handling and processing, analytical procedures, reporting requirements, and other matters necessary or desirable for harmonization.

Preparation of the Guidelines was based on the output of the international workshop held in 2015 as a follow-up to the “*G7 Action Plan to Combat Marine Litter*” agreed on in the G7 Elmau Summit 2015, and a follow-up meeting held in 2019 based on “*G20 Implementation Framework for Actions on marine plastic litter*” endorsed in the G20 Osaka Summit 2019. It was indicated that Japan would lead the harmonization efforts for microplastic monitoring methods in the workshop and the follow-up meeting held in 2019.

The Guidelines were developed on the basis of opinions and recommendations compiled at international meetings of microplastic monitoring experts and the results of dedicated *in situ* and laboratory experiments newly conducted toward harmonization, as well as existing findings collected and summarized from published microplastic monitoring survey reports, guidelines, and manuals.

Estimating the abundance and/or distribution of microplastics in water bodies has become internationally important. At present, several sets of guidelines and other documents are being developed by some international organizations including GESAMP. The Guidelines presented here were designed to supplement and complement such documents, and to propose detailed methodologies focusing on net sampling and analysis. The outcomes of which are to contribute validated and comparable data which can be used to produce horizontal distribution maps (two dimensional maps; 2-D maps) of microplastics at the global ocean surface.

Many studies are expected to be carried out to monitor microplastics at the ocean surface. The application of the harmonized methods proposed in the Guidelines will support these efforts to generate comparable results. Thus, enabling researchers to analyze, consolidate and integrate the results on a wider scale. Through such an application, we strongly believe that our understanding of the abundance of microplastics in the ocean will improve. Shared and integrated monitoring results will promote higher level analysis of microplastic issues and application to policy development.

These outcome and progress will be share at various international meetings including G20.

The first revision of the Guidelines was made one year after their first publication and this second revision was made two years after the first revision. The Guidelines will be updated and improved as necessary.

Contents

1. Introduction.....	1
1.1 Background and purpose.....	1
1.2 Scope of the Guidelines.....	5
1.3 Composition.....	7
2. Sampling methods.....	8
2.1 Outline.....	8
2.2 Sea conditions.....	10
2.3 Sampling equipment.....	13
2.3.1 Sampling vessels.....	14
2.3.2 Net types.....	16
2.3.3 Mesh openings.....	19
2.4 Tow parameters.....	24
2.4.1 Tow duration.....	24
2.4.2 Vessel speed.....	26
2.4.3 Sweep area and filtered water volume.....	26
2.4.4 Tow distance.....	27
2.4.5 Tow position.....	31
2.4.6 Net immersion depth.....	35
2.5 Metadata.....	38
2.6 Field sample blanks.....	40
3. Laboratory analysis.....	43
3.1 Outline.....	43
3.2 Preprocessing for analysis.....	45
3.2.1 Biological digestion and chemical treatment.....	46
3.2.2 Density separation.....	49
3.2.3 Sample splitting.....	51
3.3 Isolation of microplastic.....	53
3.4 Counting and size measuring.....	55
3.5 Material identification.....	58
3.6 Weight measurement.....	62
3.7 Accuracy control during analysis.....	64
4. Reporting.....	66
5. Conclusions.....	71

List of Acronyms and Abbreviations

CMSM2018: Comparison of Microplastic Sampling Methods 2018

CMSM2019: Comparison of Microplastic Sampling Methods 2019

CPR: Continuous Plankton Recorder

EC: European Commission

FTIR: Fourier Transform Infrared Spectroscopy

GESAMP: The Joint Group of Experts on the Scientific Aspects of Marine Environmental Protection

ILC: Inter Laboratory Comparison 2017

MOEJ: Ministry of the Environment, Japan

NOAA: National Oceanic and Atmospheric Administration

SOP: Standard Operational Procedure

1. Introduction

1.1 Background and purpose

Marine litter, including microplastics, is now a global challenge. In particular, pollution of the marine environment by microplastics has been recognized as a serious international issue. Microplastics are likely to affect marine ecosystems and are extremely difficult to recover. Determining the current status of distribution and quantity of microplastics in the ocean is an urgent task. It is important for policy making and implementation to be based on concrete scientific knowledge. Early intervention and mitigation can be facilitated when environmental concentrations are understood. Thus, effective monitoring tools can support preventive measures against plastic litter in the ocean.

In response to the growing interest surrounding microplastics in the ocean, microplastic monitoring (sampling and laboratory analysis) is carried out by many institutions around the world using various methods. Accordingly, data are gradually accumulating. It is expected that monitoring will continue, but as different sampling and analytical methods are used - depending on the purpose of the surveys of each country and research institution - there is a fundamental lack of comparability among currently available data. In some instances, research will be carried out under limited resource availability, technical capacity or institutional arrangements. Alternatively, monitoring will be conducted using emergent methodologies and is not yet globally common. These factors will further hamper researchers' ability to build comparisons.

Methods that are of a high technological readiness level (TRL) for plastic monitoring are essential to generate harmonised and comparable data (Lusher and Primpke, 2023). Methods can be broken into different analytical steps and a TRL applied to all steps (Aliani et al., 2023). TRLs can help distinguish which methods are at a level which is mature enough to be considered for large-scale monitoring guidelines or those that need to be redirected into research and development (such as investigating microplastics in air). The TRL scale classifies technology or methods into basic research (TRLs 1–3), applied research (TRLs 4–5), in development (TRLs 6–8) and implementation (TRL 9) phases. Using the scale in Aliani et al., (2023), methods for microplastic sampling and sample processing would fall under development or applied research phase.

The inability to compare data obtained by different monitoring methods may pose an obstacle to determining the global distribution and fate of microplastics in the ocean. Hence, harmonization (and where possible standardization) of monitoring methods for microplastics are recognized as important tasks.

At the G7 Elmau Summit in 2015, marine litter, especially plastic, was acknowledged as a global challenge due to its (1) effects on ocean and coastal ecosystems, (2) direct impacts on ecosystems, and (3) potential impacts on human health. In the annex to the G7 2015 declarations, “*supporting the initiation of a harmonized global marine litter monitoring effort and the standardization of methods, data and evaluation*” is listed as one of the priority actions. Subsequently, the communiqué adopted at the G7 Toyama Environment Minister's Meeting in 2016 states its commitment to implementing five priority measures including standardization and harmonization of monitoring methodologies for marine litter. Based on shared recognition of these issues, several activities have been initiated including development of guidelines for monitoring, analysis and evaluation by GESAMP and other

organizations. At the expert workshop in Berlin, November 2015 following the Elmau Summit, it was agreed that Japan would play a leading role in standardizing and harmonizing the monitoring methodologies for ocean microplastics.

At the G20 Osaka Summit in 2019, marine plastic pollution was taken up as one of the priority issues. The “*Osaka Blue Ocean Vision*”, which aims to reduce additional pollution by marine plastic litter to zero by 2050, was shared as a common global vision, and the G20 leaders called on other members of the international community to share the vision. They also endorsed the “*G20 Implementation Framework for Actions on Marine Plastic Litter*”, which includes sharing scientific information and knowledge. The first follow-up meeting and the G20 Workshop on Scientific Knowledge and Innovative Solutions for Marine Plastic Litter were held in 2019. The meeting identified future activities anticipated for the G20 Implementation Framework, including joint initiatives of Ministry of the Environment, Japan (MOEJ), EU DG Environment and US Environment Protection Agency to voluntarily take a lead in further elaborating key issues such as harmonized monitoring and data compilation by MOEJ.

To remedy the situation, the MOEJ has been advancing efforts to ascertain the actual state of marine pollution by encouraging to horizontal distribution mapping of microplastic densities at the ocean surface worldwide. The Guidelines were developed based on the results of three projects, implemented by scientists and supported by the MOEJ (Fig. 1-1). In addition, a comparative study of the research being undertaken around the world was conducted. For examining analytical methods, an **inter-laboratory comparison (ILC)** was conducted by 12 laboratories in 10 countries (Canada, China, Korea, Norway, Russia, Spain, Switzerland, Thailand, USA and Japan) in 2017 to cross-check standard samples containing a predetermined amount of non-plastic material and a predetermined number density of plastic particles using various analytical methods (Isobe et al., 2019). For examination of sampling approaches, a **comparison of microplastic sampling methods** was conducted in FY2018 (hereinafter “CMSM2018”), by sampling microplastics in the sea surface of Tokyo Bay. In FY2019, the **comparison of microplastic sampling methods** (CMSM2019) was implemented in Sagami Bay to further enhance the content of the Guidelines. Based on an analysis of differences in the results obtained in these projects, recommendations for harmonization, as well as points to be noted when interpreting monitoring results were summarized. Furthermore, due to the considerations being made for a newly developing database for marine plastics (Marine Plastic Litter Mapping Database) and progress in other related activities, some definitions used in the Guidelines needed to be amended for practical reasons.

The Guidelines were prepared with the view of enabling researchers of ocean surface layer microplastic monitoring to adopt similar monitoring protocols and therefore interpret their results with a level of comparability.

Purpose of the Guidelines:

- To focus on determining the actual state of microplastics in the ocean surface layer* rather than other forms of marine plastic pollution.

- To provide recommendations for harmonizing sampling and analytical methods which will enable comparison of the obtained results both of currently ongoing and future studies.
- To give consideration to studies carried out under various constraints, such as restrictive human or financial resources.

* Microplastic monitoring surveys have been carried out for many different purposes (Rochman et al., 2017) such as to evaluate diverse media or the effects of microplastic emission controls. Among these various research objectives, the Guidelines aim specifically at developing horizontal distribution maps of microplastics at the ocean surface.

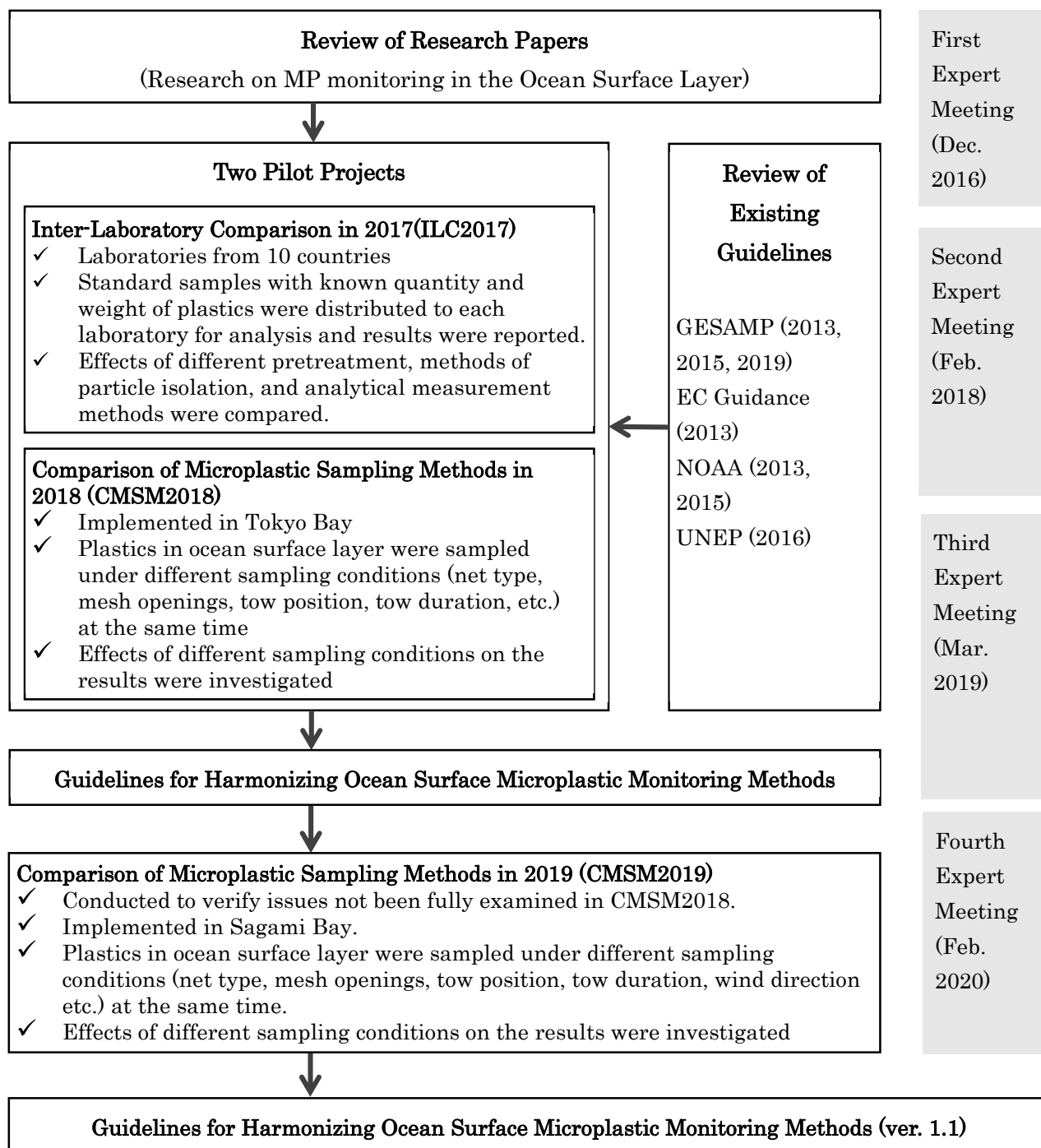

* Microplastic monitoring surveys have been carried out for many different purposes (Rochman et al., 2017) such as to evaluate diverse media or the effects of microplastic emission controls. Among these various research objectives, the Guidelines aim specifically at developing horizontal distribution maps of microplastics at the ocean surface.

Fig. 1-1. Guidelines development and updating process.

1.2 Scope of the Guidelines

Target readers

- The main target readers of the Guidelines are researchers who conduct oceanographic surveys of microplastics, and those who intend to analyze and evaluate the state of pollution by using survey results of their own and/or others from around the world. Consideration has been given to some studies carried out in various countries including developing countries under various constraints, such as restrictive human and financial resources.
- The Guidelines are not intended to present standards, but rather they have been prepared in the expectation that they will be helpful in choosing harmonized methods that would derive comparable results.

Subject and monitoring methods

- The subject matter of the Guidelines is microplastics at the ocean surface and their aim is to harmonize net sampling in the field and analytical methods in laboratories.
- Plastic particles with a size of less than 5 mm are treated as microplastics in the Guidelines, similarly to their definition in GESAMP (2019) and to the definition used in international organizations and many research projects that have been implemented in various countries around the world.
- Ascertaining microplastic presence inside living organisms is important to investigate the impact of microplastics on living organisms, but it is beyond the scope of the Guidelines.
- Although the scope of the Guidelines is microplastics at the ocean surface, as shown in Table 1-1, the sampling and laboratory analytical methods are considered applicable to surface water in both marine and freshwater environments. They can also be partially applicable to water columns and sediments of both seawater and freshwater.

Table 1-1. Microplastic sampling and analytical methods within the scope of the Guidelines.

Legend ○: Within the scope △: Partially referable ×: Not within the scope of the Guidelines

The Guidelines have been designed primary for marine surveys. It should be noted there would be more clogging and vertical mixing in fresh water.

Category		Field Sampling	Laboratory analysis
Surface water	Net sampling	○*	○
	Other methods (Pump, CPR, etc.)	×	△
Water column		×	△
Sediments		×	△

Why focus on ocean surface net sampling?

Presently, there are numerous microplastics in the ocean surface around the world. They are impacting invertebrates, fish, birds and other organisms living in or on the ocean surface.

At the ocean surface, it is common to collect samples using nets. Net sampling is thought to have the following advantages:

- A large mass of water can be efficiently filtered.
- Nets can be deployed easily, compared to pumps, CPR (continuous plankton recorders), etc.,
- Abundant knowledge on surface net use and collection methods is available from plankton research.
- Proportionally more surveys using nets to sample microplastics have been conducted, so using nets facilitates comparison with the accumulated data.

1.3 Composition

The Guidelines are divided into five chapters. Table 1-2 gives an outline of these. Each chapter is divided into sections, and the main content in each section is summarized as keynotes.

Each set of keynotes is highlighted in a box and provides the following information:

- Introduction of commonly used methods and parameters.
- Related results from projects (ILC, CMSM2018 and CMSM2019) and the results of literature reviews conducted for preparing the Guidelines.
- Recommendations based on the above information.

Further comments pertaining to keynotes are provided as explanatory notes.

Table 1-2. Guidelines chapter outlines.

Chapter	Contents
1. Introduction	Background, purpose and scope of the Guidelines.
2. Sampling methods	Summary of recommendations for harmonization of ocean surface layer microplastic sampling methods, specifically for sea conditions during the survey, sampling equipment, tow parameters, metadata recording, contamination prevention and accuracy control.
3. Laboratory analysis	Summary of recommendations in view of harmonizing microplastic analytical methods in the laboratory, specifically for preprocessing, extracting microplastics, particle counting and size measurement, material identification, weight measurement and accuracy control during analysis.
4. Reporting	Recommendations on methods of reporting microplastic results and metadata.
5. Conclusions	Summary of the Guidelines, items that require further consideration, etc.

2. Sampling methods

2.1 Outline

- Microplastics floating at the ocean surface can be collected by towing a net according to the procedure illustrated below (Fig.2-1).

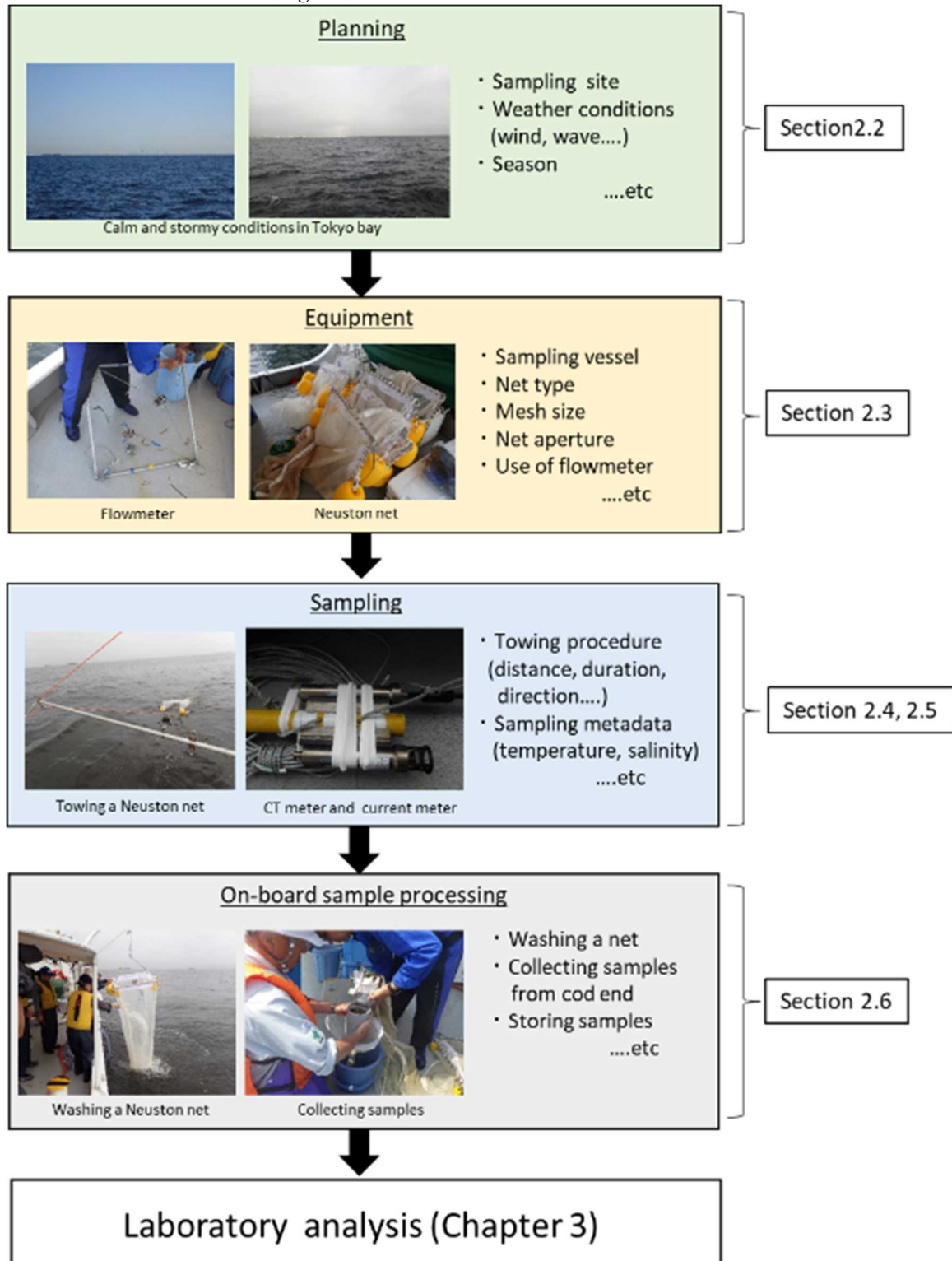

Fig.2-1. General flow of microplastic collection using a net.

- Reviews of previous research identified differences in the net type and size of mesh used across studies. A Manta net or Neuston net is most commonly used, and recommended in sampling guidelines, although differences between net mesh openings and towing methods have been observed between past studies. For this reason, surveys to collect microplastics from the ocean surface were conducted (CMSM2018 and CMSM2019) to investigate the effects of the following factors on sampling results: (1) different towing directions relative to wind direction (Section 2.2), (2) differences between Neuston nets and Manta nets (Section 2.3.2), (3) differences in mesh openings (Section 2.3.3), (4) differences in tow duration (Section 2.4.1), and (5) differences in tow position (i.e., towing at the stern) (Section 2.4.5).
- CMSM2018 was conducted using a research vessel in Tokyo Bay whereas CMSM2019 was conducted in Sagami Bay closer to the open ocean. This survey was conducted with a small fishing boat equipped with outfitting that made it possible to tow on the sides of the vessel. The survey method using a small fishing boat is summarized in the Section 2.3.1.
- The average density of microplastics at the ocean surface observed in CMSM2018 in Tokyo Bay was 2.65 particles /m³ (Range: 0.21 - 6.49 particles /m³, 78 x 10³ - 2,432 x 10³ particles/km²). Density has generally been reported in either one of the two unit systems: one is the particle number per unit volume and the other is per unit area. Comparatively, the average density of microplastics in CMSM2019 at Sagami Bay was 0.51 particles/m³ (Range: 0.03- 2.57 particles/m³, 13 x 10³-956 x 10³ particles/km²).
- Conditions for harmonization were determined based on a comparison between the results of the CMSM2018 and CMSM2019 where net types with different mesh openings were towed at the same time in the same sea area. Specifically, two different nets were simultaneously set at port and starboard of the same survey vessel.
- In order to confirm the validity of this method, test runs were conducted using two Neuston nets of the same design towed at port and starboard positions. There were no statistically significant differences between the densities of microplastics (Section 2.4.5).
- The metadata necessary to enable comparison of the survey results were examined based on the environmental data acquired during CMSM2018 and CMSM2019.
- Recommendations based on our literature review and field study (CMSM2018 and CMSM2019), are presented in detail in the following section.

2.2 Sea conditions

Keynotes

- Previous studies and available guidelines have stated that the collection of microplastics at the ocean surface should be conducted under calm sea conditions whenever possible. Adverse weather conditions can affect the results obtained.

Outcomes of the pilot projects

- It was observed that the density of microplastics in the same survey area changed by about one order of magnitude within several hours. This occurred as sea conditions, including wind speed and wave height, changed.

Recommendations

- It is desirable to collect samples when sea conditions are as calm as possible. This might not be practical in areas prone to elevated wind conditions. In such situations, metadata such as wind speeds and significant wave heights should be recorded to allow comparisons with other survey results (for more details, please refer to Section 2.5, Metadata and Section 4, Reporting).
- It is desirable to avoid unfavorable timing and conditions for sampling, such as high densities of natural particles or organisms, i.e. algae and plankton blooms. When conducting a survey under unfavorable conditions is unavoidable due to characteristics of sea areas, it is desirable to consider appropriate methods such as shortening the tow duration accompanied with repeated towing, and frequently washing towing nets (Section 2.4.1).

Explanatory Notes

- In general, wind speed and wave heights are known to influence the degree of vertical mixing of the ocean surface layer and affect the amount of microplastics collected. According to recent guidelines, microplastic surveys should be conducted in conditions where wave heights are under 0.5 meters and the beaufort wind force scale under 3 (GESAMP, 2019).
- Several studies that have been conducted propose a method for estimating the vertical distribution of microplastics in the water column allowing researchers to correct ocean surface microplastic density depending on sea conditions (Kukulka et al., 2012; Kooi et al., 2016. etc.). Recording wind speed and wave height during sampling will allow researchers to estimate the vertical distribution of microplastics in the water column and some studies have adopted these methods (Isobe et al., 2015; Suaria et al., 2016. etc.).
- In CMSM2018, it was observed that the density of microplastics at the ocean surface decreased in situations where both wind speed and wave height increased during sampling (Fig.2-2). This was probably due to the enhanced mixing of the ocean surface layer caused by changes in the sea conditions and the dispersion of microplastics to a certain depth (Reisser et al., 2015).
- In CMSM2019, the results of microplastic sampling were compared to examine towing direction with respect to the wind direction in the open sea, where a net was towed perpendicular to the wind direction, with the starboard side facing upwind and the port side facing downwind under calm sea conditions (wind speed 2-6 m/s).

- The results showed no statistically significant difference between the particle densities in samples (1-5mm) collected upwind and downwind (Fig. 2-3). It should be noted that results were obtained using a small boat of 10 tons under calm sea conditions. The results could not necessarily be applied to other conditions.
- Care should be taken when sampling in sea areas near land following rainfall, as it has been reported that the density and composition of microplastics at the ocean surface can be influenced by microplastics input from rivers (Kang et al., 2015., Lima et al., 2015, etc.).
- In CMSM2018, surveys conducted in the coastal area of Tokyo Bay showed an increased density of microplastics. This observation was thought to have been caused by the input from nearby rivers (Section 2.5, Fig.2-16).
- In addition, a significant decrease in the amount of microplastics was observed when a large amount of jellyfish was caught in the same net in CMSM2018. Clogging of the net by plankton, algae, jellyfish, floating seaweed, etc., affects survey results. It is preferable to avoid collecting samples at times when they are expected to be observed in mass.
- To obtain mutually comparable results, situations with strong winds and/or waves, or in which plankton are highly abundant should be avoided. Surveys must be conducted when sea conditions are as calm as possible.
- Tidal currents and/or river inflows should be monitored. Sampling should be conducted under moderate to average sea conditions to increase comparability.
- Additionally, under rough sea conditions, it might be difficult to maintain the immersion depth as constant, and the flowmeter may not be able to measure the filtered water volume correctly because the meter may sometimes be outside of the sea surface.
- The flowmeter should always be periodically calibrated so that its metering conforms to the standard.

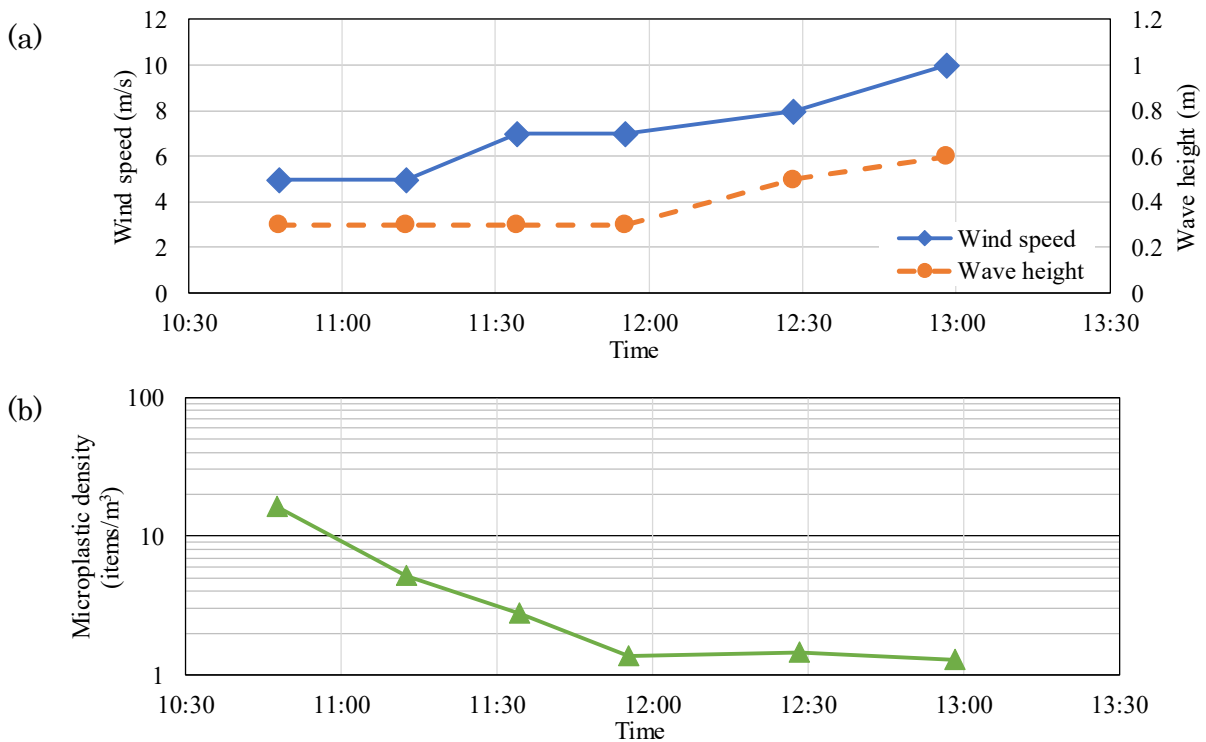

Fig.2-2. Example of temporal changes in wind direction and wave height (a) and density of microplastics (b) measured in CMSM 2018.

Wind speed, wave height and density of microplastics are plotted at towing commencement times.

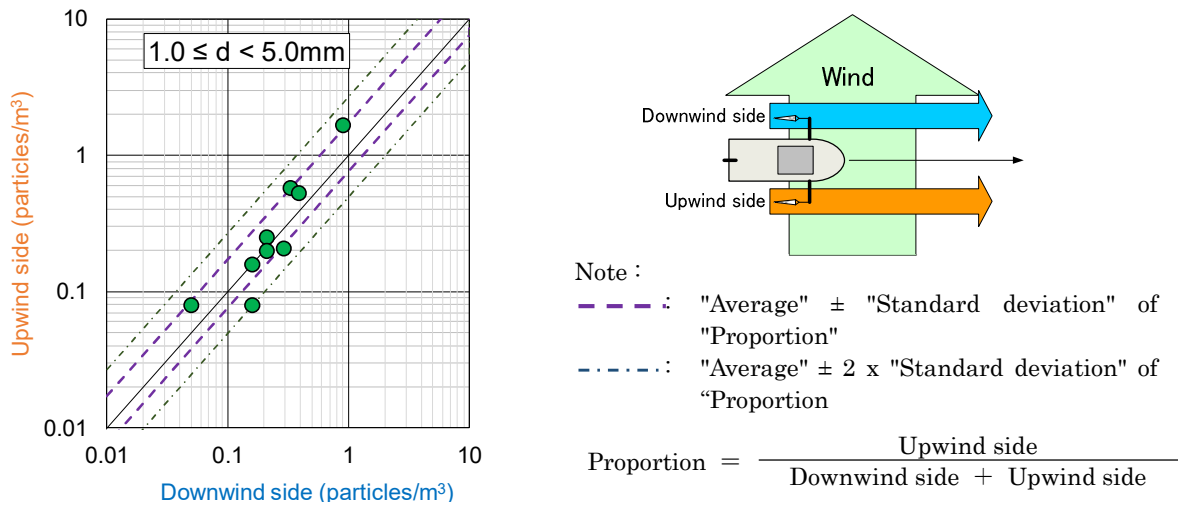

Fig. 2-3. Comparisons among different positions of sampling gear relative to wind direction

Table 2-1. Influence of sampling gear positions on microplastic samples. Displayed here are results of in CMSM2019.

Proportion represents the ratio of between positioning factors

	Proportion	
	Port vs starboard Towed in the same wind direction (Towed parallel to the wind direction)	Upwind side vs downwind side (Towed perpendicular to the wind direction)
Numbers of data	20	9
Average of proportions	0.53	0.53
Standard deviation	0.13	0.11
T test	T value	-0.04
	P value	0.48

2.3 Sampling equipment

- To collect microplastics floating at the ocean surface, most researchers use nets that can efficiently filter a large mass of water (Neuston, Manta or other nets).
- Since microplastics are considered to exist in the ocean heterogeneously, it is desirable to sample large volumes of sea water to obtain representative values in the sea area.
- Since Neuston nets and Manta nets have been widely used in plankton surveys, knowledge has accumulated on trawling methods that can facilitate their introduction for anyone wanting to start or expand investigations of microplastics in the future. Also, their use makes it easier for the data obtained to be compared with data accumulated in the past.
- When net sampling, particles smaller than the mesh openings escape through the net. Therefore, when collecting smaller particles, it would be more effective to sample the water using bottles, buckets, pumps, etc., and filter the water on the vessel, or collect the ocean surface water using a mesh screen sampler.
- It should also be noted that the results obtained using other sampling equipment may not be directly compared to results obtained by net sampling because the differences in the sampled layer and collected water volume are extremely large. To compare the results of such surveys, further discussion on harmonization is needed.
- Recently, unique devices for sampling have been proposed, for example, a series of sieves with different mesh openings installed within the cod end of Manta net to fractionate plastic particles by size whilst towing (Syakti et al., 2018).
- When research vessels are not available, small fishing boats could be used instead of the research vessels. Small boats usually had no equipment to tow nets. Therefore, it is necessary to prepare additional simple equipment for towing. In CMSM2019, microplastic surveys were conducted using small boats after the installation of an appropriate outfitting. The survey method using small fishing boats is summarized in Section 2.3.1).
- The following section highlights points to be noted regarding equipment to be used for surveys by net towing.

2.3.1 Sampling vessels

Keynotes

- Oceanic surveys are usually conducted on research vessels. This may not always be convenient as the number of the research vessels is limited and large vessels cannot navigate in shallow areas. In addition, using research vessels for a single mission may not be economical.
- Smaller vessels could be used in place of research vessels. However, equipment such as cranes to perform towing may need which might present a limiting factor in conducting surveys.

Outcomes of the pilot projects

- A method of towing from the side of a small boat was investigated. A small fishing boat was outfitted using several pipes, a clamp for fixing the pipes and a rope for supporting the pipes. Successful microplastic sampling was conducted from the sides of the small boat accordingly.

Recommendations

- With proper outfitting, it is possible for small fishing boats to tow sampling nets from the sides of the boat.
- The following points should be considered.
 - (1) To avoid the effects of the bow wave, outfittings (pipes) should be set at an appropriate length to keep the nets away from the hull. Outfittings should also be installed at the sides and as far forward as possible of the boat to avoid the effect of the wake. This is also considered to be effective methods from the viewpoint of avoiding contamination.
 - (2) The outfittings should be fixed to a place on the vessel that is strong, secure and stable, such as a boat bollard.
 - (3) To prevent damage to the outfittings, the ends of the pipes should be stabilized with tension using a support rope.
- Nevertheless, it is vital to pay close attention to safety management to prevent damage to the outfitting, and also to prevent contamination from paint and cushioning materials on the vessel (see Section 2.6).

Explanatory Notes

- In CMSM2019, the feasibility of towing with the simple outfitting of small boats was examined. The boat used was a fishing boat with a gross tonnage of 13 t and a whole length of 11.97 m. Although the vessel was not equipped cranes or booms, it is desirable to sample from sides of the boat therefore simple installations of outfitting were performed before the surveys commenced.

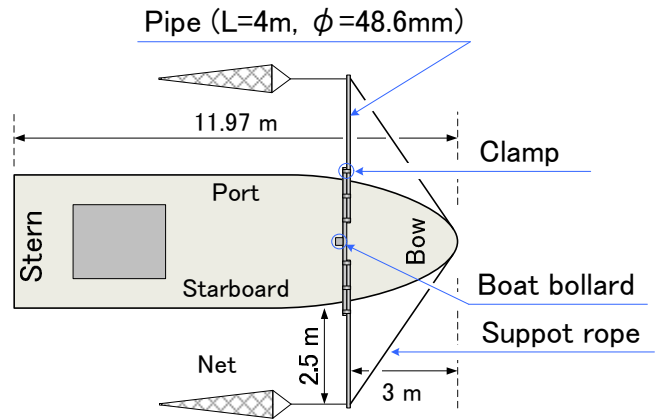

Fig. 2-4. Towing was performed by simple outfitting on fishing boat in CMSM2019.

- In the outfitting shown in Fig. 2-4, it was possible to tow the nets beside the boat. However, due to the simple outfitting, special attention was required in the following points adding recommendation noted.
 - ✓ Rigging strength is relatively weak on a simple outfitting. Thus, towing at an appropriate speed (1-2 knots) is considered necessary (Section 2.4.2).
 - ✓ When a net of 0.10 mm mesh opening is towed, or when high quantities of biological material (e.g. fish eggs) are present, attention should be paid to protecting the outfitting, for example, by washing the net along the way (Section 2.4.1).
 - ✓ The field blank test clearly identified particles of paint and cushioning material fragments generated from the fishing boat (Section 2.6).

2.3.2 Net types



Neuston net



Manta net

Keynotes

- Neuston nets or Manta nets are most commonly used for sampling at the ocean surface.
- Each type of net has its own features:
 - (1) Neuston nets can capture the ocean surface layer in wavy conditions. However, it is difficult to estimate the volume of water filtered accurately because the net's immersion depth changes constantly.
 - (2) Manta nets can maintain a constant immersion depth at the sea surface. Filtered water volume can be estimated fairly accurately providing there are no waves on the sea surface and the net maintains position. If the wave height exceeds a certain level, the net tends to jump and skip on the water surface.
 - (3) In addition, the results obtained by a Catamaran net, the shape of which lies somewhere between Neuston nets and Manta nets, were comparable to the results obtained by a Neuston net when the particle diameters were 1 mm or larger.

Outcomes of the pilot projects

- The number of particles per unit of filtered water volume was compared for particles larger than 1 mm and less than 5 mm in their maximum Feret's diameter (Section 3.4) sampled by simultaneous towing using a Manta net and a Neuston net in the same area. The results showed the number of particles captured by the Manta net tended to be slightly higher than by the Neuston net, although not statistically different. This tendency was thought to be caused by differences in net immersion depth.

Recommendations

- Results obtained with different net types are thought to be comparable when the nets have similar immersion depth or the effects derived from different net immersion depth can be calibrated.
- Assuming that either a Neuston net or Manta net will be selected based on the respective advantages and limitations of each (to suit the purpose of the survey and conditions in the target sea area optimally). It is necessary to report weather and sea conditions at the time of sampling along with net immersion depth.

Explanatory Notes

- Neuston nets with a side length of about 45 to 100 cm, or Manta nets with a width of 60 to 100 cm and a height of about 15 to 40 cm are most commonly used to collect microplastics from the ocean surface. Both net types were developed and designed to collect plankton in the surface layer.
- The Neuston net used in CMSM2019 (JMA Neuston net, RIGO Co., Ltd., No.5552) had a square net mouth width and height of 75 cm each, and a net with 0.35 mm mesh openings. When towing the Neuston net, immersion depth was set to 1/2 of the height (37.5 cm). The Manta net (Manta net system, Ocean Instruments, Inc., OI-100) had a rectangular net mouth 100 cm wide and 20 cm in height, and a net with 0.35 mm mesh openings (in place of the originally attached net). When towed, the Manta net was submerged to the upper end of the net mouth.
- A comparison between a Manta net and a Neuston net was conducted by simultaneously towing the nets during CMSM2019. The results were compared in terms of the number of collected plastic particles (1-5 mm) per unit filtered water volume for particles. The Manta net tended to have densities of microplastics which were slightly higher than those of the Neuston net although there was no statistical difference between the two (Fig. 2-5).
- The Manta net is thought to have contained a slightly higher number density as it collects the very surface of the water, where a high density of plastic particles is likely to occur.
- The proportion in the value by Manta net to the value by Manta and Neuston nets (Fig. 2-5) was calculated to be 0.58 for observed microplastic densities collected with Manta and Neuston nets in CMSM2019. The proportion value is expected to be 0.5 if there were no differences between two nets.
- As mentioned in Section 2.2, some studies (Kukulka et al., 2012; Kooi et al., 2016, etc.) have proposed methods for estimating the vertical distribution of microplastics in a water column by using wind speeds and wave heights during sampling. With an appropriate estimate of the vertical distribution of microplastics in the water column, it is possible to compare the density of microplastic from nets at different immersion depths.
- When the differences in their immersion depths were taken into account, the proportion was estimated to be 0.59 using the formula proposed by Kukulka et al (2012) using the wind speed and wave height at the time of sampling. When estimated values are close to the observed values with the correction, this may verify that the differences in particle the collection between Manta and Neuston nets were attributable to their different immersion depths.
- Similarly, Eriksen et al., 2017 reported that although there was no statistical difference in the number density of plastic particles collected with a Manta net (net immersion depth: 16 cm) and an AVANI net (elongated rectangular Neuston net with an aspect ratio of about 5: 1 and net immersion depth of 30 to 60 cm), there was a statistically significant difference in weight of particles. This difference is speculated to have arisen from a difference in collection layer and a tendency for plastics at relatively high densities to float slightly below the surface layer, such that the AVANI net would catch more particles in high density areas than the Manta net.

- For nets used for quantitative collection, the net opening ratio (ratio of the total area of the net's mesh openings to the area of the net's mouth opening) needs to be 5 or more when using a net with mesh openings of 0.3 mm or more (Tranter & Smith, 1968), and preferably 9 or more when using a net with smaller mesh openings (Saito, 2018).
- For the net sampling of microplastics at the ocean surface, conducting sampling under conditions that avoid clogging and inhibition of filtering is recommended, in addition to confirming the net opening ratio of the net to be used.

Table2-2 Advantages and disadvantages of different nets for collecting floating microplastics identified by CMSM2019.

	Advantages	Disadvantages
Manta net	Remains in surface water except in rough water.	Tends to jump and skip on rough water.
Neuston net	Operates in relatively rough water.	Needs some efforts to maintain the stable net immersion depth.

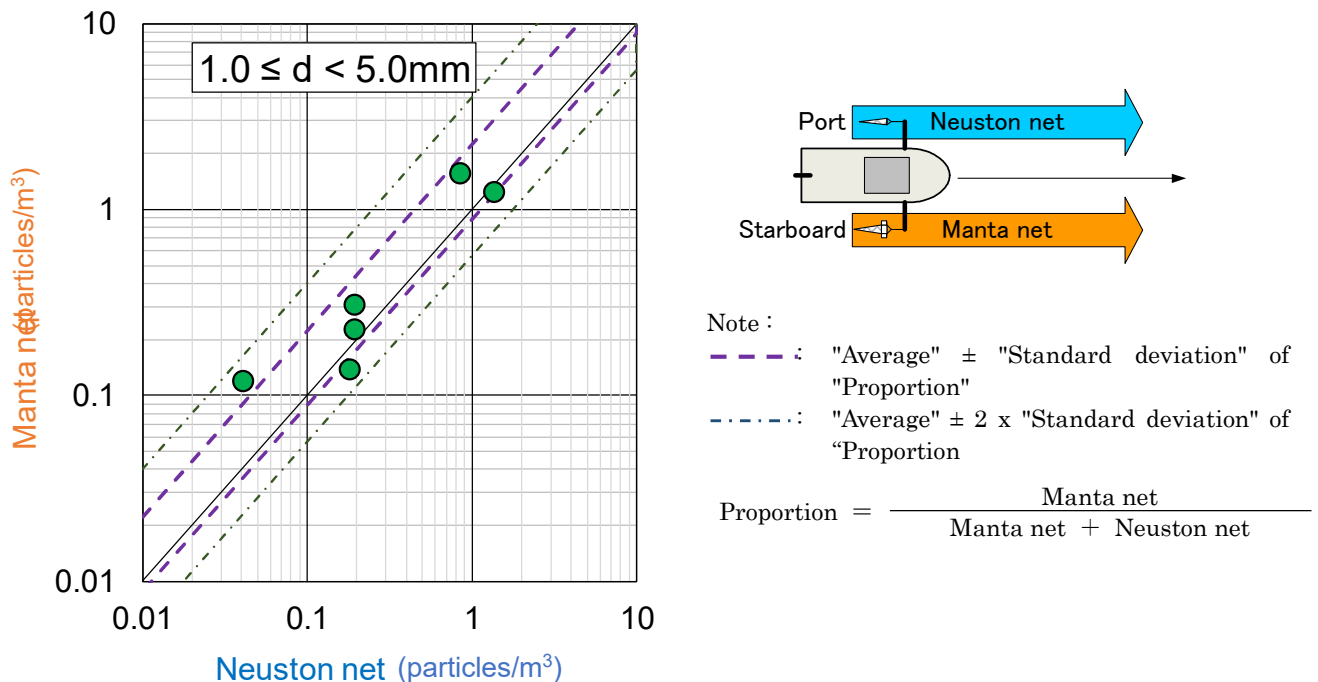

Fig. 2-5. Comparisons between different net types in CMSM2019.

Table 2-3. T test results of significant difference in the density of microplastics between different net types (in CMSM2019).

Proportion is the ratio of the 'Manta' value to the sum value of 'Neuston' plus 'Manta.'

		Proportion	
		Port (Neuston) vs starboard (Neuston)	Starboard (Manta) vs Port (Neuston)
Numbers of data		20	6
Average of proportions		0.53	0.58
Standard deviation		0.13	0.12
T test	T value	-0.84	
	P value	0.20	

2.3.3 Mesh openings

Keynotes

- In general, past surveys generally used mesh openings of about 0.3 mm. Reasons for this choice include the ability to filter large amounts of seawater, suitability for sea conditions and plankton abundance. Nets with mesh openings of 0.20 mm or 0.10 mm have also been used.

Outcomes of the pilot projects

- Two Neuston nets with the same design but with different mesh openings, 0.35 mm and 0.1 mm, were employed in the pilot projects. Both nets were towed simultaneously. There was no significant difference in the number of particles > 1 mm in size. However, for particles < 1 mm, the number of particles collected with a net with mesh openings of 0.10 mm was about four times larger compared to those collected with a net with 0.35 mm mesh openings (Table 2-4).
- Many sticky fish eggs were observed surface waters when the nets were towed to study differences between mesh openings. Nets with 0.1 mm mesh openings were clogged with the fish eggs. Therefore, this may have attributed to the collection of fewer particles by nets with 0.1 mm mesh openings.
- Additionally, a significant decrease in precision was observed in ILC on microplastic analysis for particles less than 1 mm in maximum Feret's diameter.

Recommendations

- For the purpose of comparing floating microplastic pollution of various sea areas, or from a broader, global perspective, the use of the most common mesh opening (0.3 mm) is considered desirable.
- On the other hand, monitoring using a net with finer mesh openings would be useful because data on smaller particles are essential for elucidating the behavior of microplastics in the ocean as well as the effect of uptake of by organisms.
- Obtaining data related to smaller mesh openings would be beneficial to obtaining information (providing a coefficient to convert between sizes) on smaller particles, although this can be influenced by sampling location, size distribution and the accuracy of analysis of smaller particles.
- When clogging of the net is inevitable, it is necessary to take measures such as shortening the tow duration accompanied with repeated sampling to obtain the appropriate tow duration or tow distance (see Section 2.4.1), and appropriate pretreatment to digest a large amount of organic matter in the samples before analyses (see Section 3.2.1).
- Microplastics which are similar in size to the mesh openings may be under-sampled if their shortest length is smaller than the mesh openings. It is advisable to measure and report particles <1 mm separately from particles 1 mm - 5 mm.

Explanatory Notes

- Mesh openings as used in the Guidelines is expressed as the side length of a quadrangle separated by mesh thread and through which sea water passes ((A) in the figure on right), but in some cases the length of the diagonal line ((B) in the figure on right) is used as the mesh opening. The researcher should confirm which mesh opening is meant and record the mesh opening used for the survey.
- In CMSM2018 for particles less than 1 mm, the number of particles collected with the net with mesh openings of 0.10 mm was about two to five times larger compared to those collected with the net with 0.35 mm mesh openings.
- There were fewer particles with the shortest of length less than 0.5 mm when using a net with mesh openings of 0.35 mm (Fig.2-6). It is conceivable that some particles may pass through a net with mesh openings of 0.35 mm and not be collected.
- The net with mesh openings of 0.35 mm used in CMSM2018 had rectangular openings with a side length of 0.35 mm separated by mesh thread through which sea water passed. Assuming the particles and the mesh did not distort, particles with the shortest length of 0.49 mm or less, which is the diagonal length of the mesh openings, could pass through the screen.
- In general, using a net with mesh openings of 0.1 mm or 0.2 mm enables the collection of small particles which could be under-sampled when using one with larger openings of 0.3 mm, which was also supported in CMSM2018. Considering the possibility of clogging, however, the sampling time may have to be limited in case there are high densities of natural particles or organisms, and problems may arise from the viewpoint of securing the required amount of filtered water.
- Also, in CMSM2019, similar to CMSM2018, the same two Neuston nets with different mesh openings of 0.35 mm and 0.10 mm were simultaneously towed at the port and starboard sides, and their microplastic densities were compared. There were no statistically significant differences in the numbers and densities of particles larger than 1.0 mm.
- On the other hand, the number of particles collected with the 0.10 mm mesh opening net was fewer than those with 0.35 mm mesh openings for particles smaller than 1 mm in CMSM2019. (Table 2-5, Fig.2-7) At this time, it was observed that a rotation counts of a flowmeter attached with 0.10 mm net was lower than the other and Neuston nets with 0.10 mm mesh openings were clogged with fish eggs. It might be caused by reducing in filtered volume for the 0.10 mm net due to plenty of sticky fish eggs. This clogging may cause fewer particles collected with nets of 0.10 mm mesh openings.
- If surveys are to be conducted using a net with finer mesh in sea areas or seasons where clogging may occur, depending on the purpose of the survey, it is necessary to set appropriate survey parameters to minimize the effects of clogging as much as possible parameters include the tow duration, net-washing interval. In addition, these parameters and clogging conditions should be recorded especially when the level of clogging may change during the sampling season.
- Obtaining data related to smaller mesh openings would be beneficial to obtaining information (providing a coefficient to convert between sizes) on smaller particles, although this can be influenced by sampling location, size distribution and the accuracy of analysis of smaller particles.
- In the future, it will be necessary to optimize a method for sampling in bloom conditions.

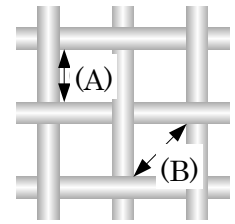

Table 2-4. Comparison of mesh openings (0.35 mm vs. 0.10 mm), number of particles obtained in simultaneous sampling cases, and their ratio in CMSM2018.

(1)'d' is maximum Feret's diameter; (2) 'Ratio' refers to the ratio of the number obtained with '0.10 mm' to that obtained with '0.35 mm'; (3) For particles of < 1 mm, final results are regarded as underestimated for both nets, due to discrepancies arising during analytical processing in the laboratory.

Sampling No.	Mesh openings (mm)	Numbers of particles (particles/sample)					
		d < 1.0 mm		1.0 – d < 5.0 mm		Total (d < 5.0 mm)	
		Number	Ratio	Number	Ratio	Number	Ratio
No.1	0.35	146	1.98	159	1.36	305	1.66
	0.10	289		217		506	
No.2	0.35	105	4.46	154	1.47	259	2.68
	0.10	468		227		695	
No.3	0.35	116	4.78	92	2.32	208	3.69
	0.10	555		213		768	
Average	0.35	122	3.57	135	1.62	257	2.55
	0.10	437		219		656	

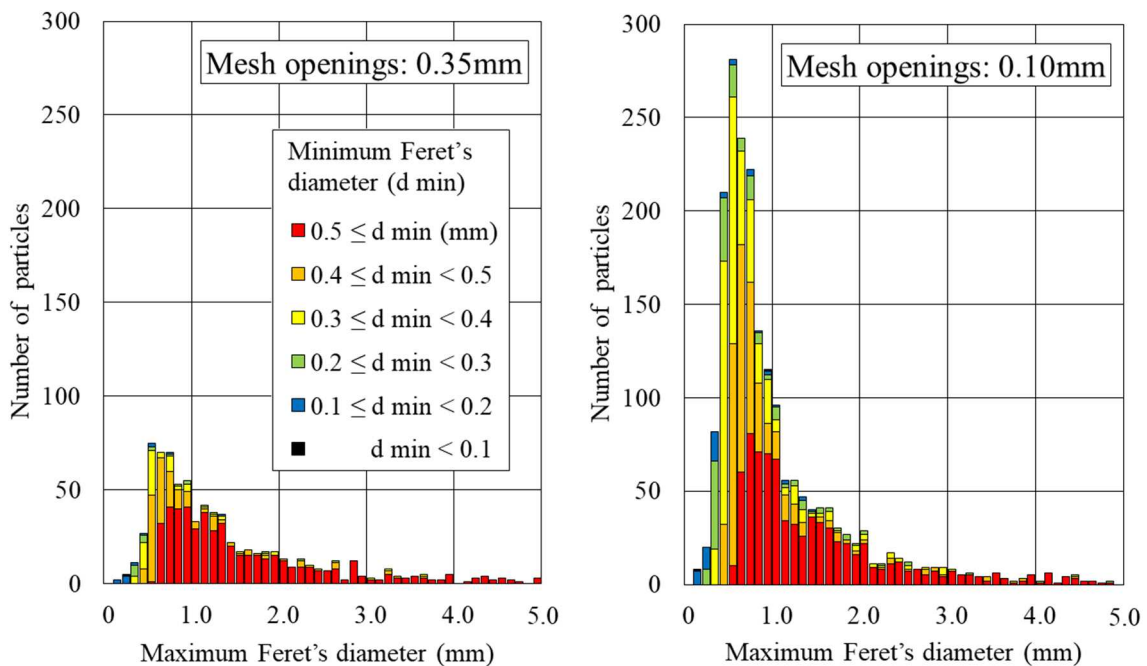

Fig.2-6. Size distribution of plastic particles collected using nets with mesh openings of 0.35 mm and 0.10 mm at the same time in the same area in CMSM2018.

The X axis plots the longest length (maximum Feret's diameter) and the color of the bars indicates the shortest length (minimum Feret's diameter).

Table 2-5. Comparison of mesh openings (0.35 mm vs. 0.10 mm), numbers of particles obtained in simultaneous sampling cases, and their ratio in CMSM2019.

Sampling No.	Mesh openings (mm)	Numbers of particles (particles/sample)					
		d < 1.0 mm		1.0 – d < 5.0 mm		Total (d < 5.0 mm)	
		Number	Ratio	Number	Ratio	Number	Ratio
No.1	0.35	30	0.12	30	0.58	60	0.43
	0.10	4		42		46	
No.2	0.35	37	0.47	19	0.42	56	0.46
	0.10	33		14		47	
No.3	0.35	55	0.35	45	0.52	100	0.44
	0.10	29		49		78	
Average	0.35	41	0.31	31	0.51	72	0.44
	0.10	22		35		57	

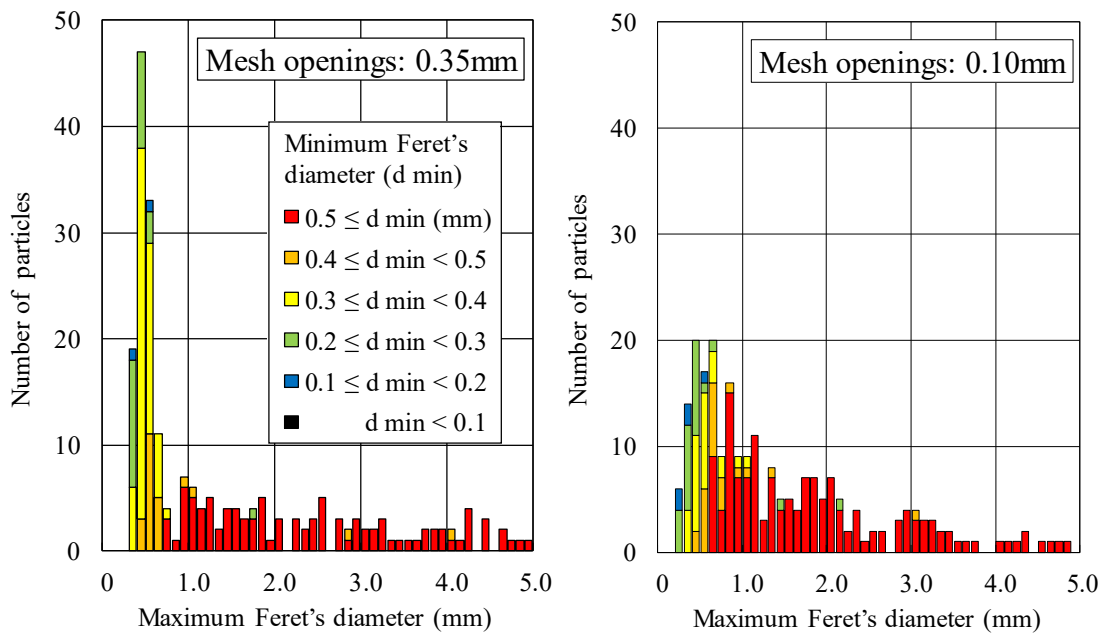

Fig.2-7. Size distribution of plastic particles collected using nets with mesh openings of 0.35 mm and 0.10 mm at the same time in the same area (in CMSM2019).

A sample at the time of collection. The bottle on the left is a sample collected by Neuston net with 0.10mm of mesh openings, and the bottle on the right is a sample collected by Neuston net with 0.35mm of mesh openings. The bottle on the left side contains more fish eggs and other floating matter.



Fig.2-8. Plastic particles collected using nets with mesh openings of 0.35 mm and 0.10 mm at the same time in the same area (in CMSM2019).

- Also, in the laboratory analysis, as described in Chapter 3, the accuracy of separating microplastic of < 1 mm decreases. Thus, in measuring microplastics collected using a net with mesh openings of about 0.3 mm, it is advisable that the results for particles 1-5 mm be reported separately from those of particles of < 1 mm in size.
- Therefore, from the viewpoint of harmonizing monitoring methods, using a net with mesh openings of about 0.3 mm is recommended as it is currently most commonly used. It should be noted, however, that even if the longest length is sufficiently greater than 1 mm, particles with a sufficiently short shortest length (fibrous particles) may pass through the net.
- Thus, it should be kept in mind that results for particles which are almost the same size as the mesh openings, and those with a much shorter shortest length may be underestimated when comparing the results collected by nets with different mesh openings.

2.4 Tow parameters

2.4.1 Tow duration

Keynotes

- Tow duration used in surveys has been 10 to 30 minutes. This usually depends on the abundance of plankton or floating matter at the ocean surface and the amount of the sampled particles required for analysis.

Outcomes of the pilot projects

- Quantities of microplastics were assessed using simultaneous net sampling in the same location to assess tow duration. Two different comparisons were conducted 1) 20 minutes towing at port side and two consecutive runs of 10 minutes towing at starboard; 2) 10 minutes towing at portside and two consecutive runs of 5 minutes towing at starboard.
- There was no significant difference in the number of particles sampled between any tows of 20 minutes, 10 minutes, or 5 minutes in duration (Fig.2-9). However, when particle density was relatively high in the ocean (~10 pieces/m³) there were discrepancies between the first and second run of consecutive tows (both 5 and 10 minutes). There was also a large variation between port and starboard results. These findings are similar to those of the study by Van del Hal et al. (2017).

Recommendations

- It is recommended that an appropriate volume is sampled to reduce the influence of heterogenous microplastic distributions, since in some cases microplastics were found floating in large patches (Van del Hal et al., 2017). For example, a tow duration of approximately 20 minutes, as seen in many of the previous studies, appears to generate sufficient data. Appropriate volume could be adjusted depending on the microplastic density in the ocean surface.
- Also, it is desirable to sweep at least 1,000 m² of ocean surface per sample. This is equivalent to 200-500 m³ of filtered water when towed with a typical net. However, this may not always be applicable depending on sampling conditions. For example, high densities of floating material (e.g, fish eggs, plankton, etc.) may hinder tow durations. It is prudent to bring a spare net. If clogged, one net could be replaced with a second one to sweep the required area of the ocean surface in a combined tow.

Explanatory Notes

- In many earlier studies, net towing was conducted for 10 to 30 minutes. At the 1st and 2nd International Expert Meetings, 20 minutes was recommended for tow duration to cover the area of trawling required to obtain representative values in the sea area.
- Regarding tow duration, many guidelines state that 15 to 30 minutes is appropriate (Lippiatt et al, 2013; EC, 2013; GESAMP, 2015; etc.). Considering the heterogeneous distribution as mentioned above, trawling for shorter durations may be inappropriate from the viewpoint of obtaining representative values in the sea area.

- In CMSM2018, the number of microplastics was compared between those collected by towing at the port side for 20 minutes or 10 minutes, and in the same sea area and at the same time, with the net at starboard exchanged in the middle of the trip to make two 10 minutes tows or two 5 minutes tows. The results showed no significant difference observed in the number of plastic particles of larger than 1 mm and less than 5 mm due to tow duration, but dispersion has been observed when densities of particles at the ocean surface are relatively high in the survey area.
- Dispersion in the results may have been due to coincidental sampling of high-density water masses, for example, from prominently heterogeneous distributions of particles that are formed when microplastic densities at the ocean surface are high.
- To capture representative values in the sea area, it is necessary to reduce the influence of such high-density water masses and obtain a leveled result.
- Consequently, it is deemed desirable to set tow duration at about 20 minutes, within a range that does not cause clogging of the mesh due to plankton or floating matter.

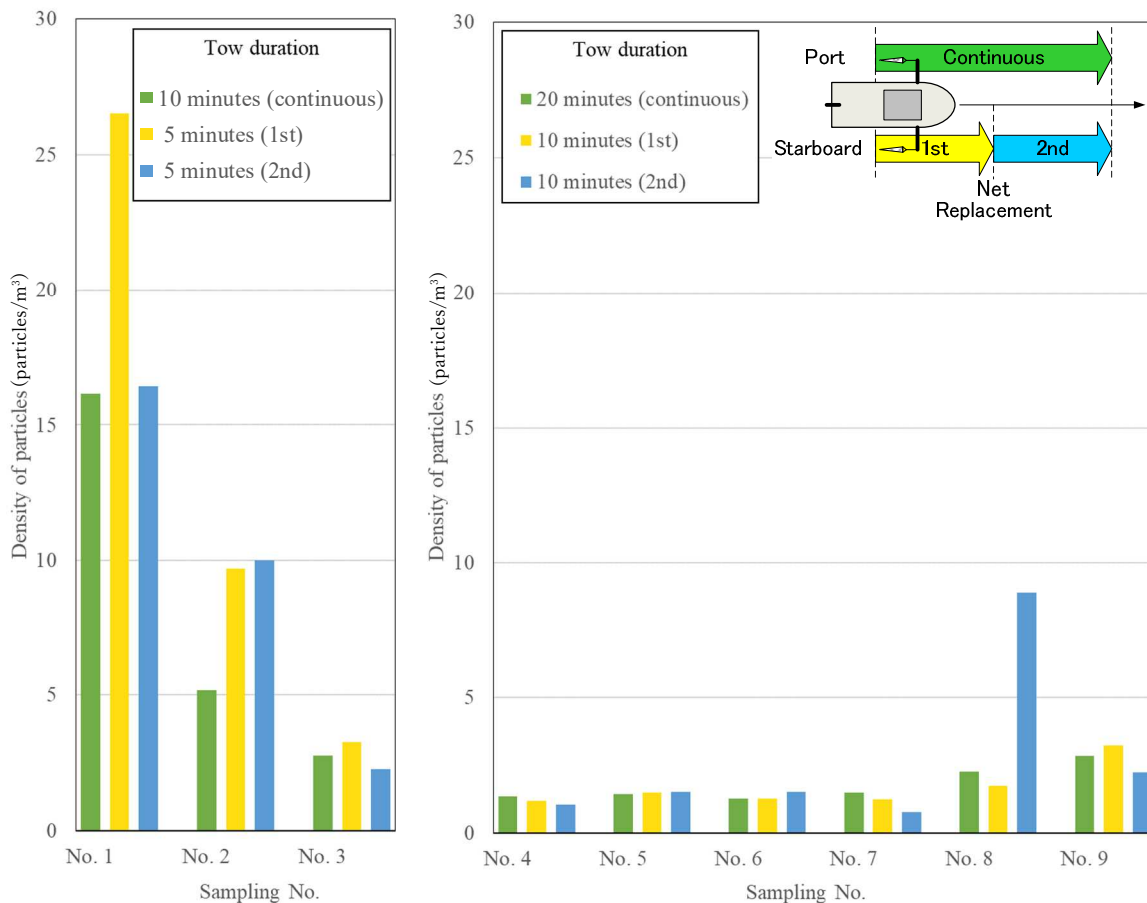

Fig.2-9. Comparison of microplastic densities at different tow durations.

2.4.2 Vessel speed

Keynotes

- Vessel speeds for sampling have been reported between 1 to 3 knots in earlier surveys.

Outcomes of the pilot projects

- Tows were conducted with a vessel speed of 1 to 3 knots against **water current** (normally referred to as log speed). Towing at 2 knots (about 1 m/sec) for 20 minutes with a net 75 cm in width resulted in approximately 1,200 m of tow distance, and samples collected from about 1,000 m² of sea surface area or approximately 350 m³ of sea water volume.
- When sampling was carried out using a small fishing boat tows had to be conducted with a vessel speed of less than 2 knots because the outrigging was relatively weak.

Recommendations

- Regarding vessel speeds for towing, if the speed is too fast, the inflow at the net mouth becomes turbulent and the filtering efficiency may decrease (Ogi, 1991; GESAMP, 2016). It is thought that the towing vessel speed should be set at 1 to 3 knots, although this depends on the type of equipment and vessels used.
- When sampling is carried out using a small fishing boat, simple outfitting should be provided. As the rigging can be relatively weak in simple outfitting, a reduced towing speed (1-2 knots) is considered necessary.

2.4.3 Sweep area and filtered water volume

Keynotes

- Microplastics observed at the ocean surface are often reported as the number of particles or weight per unit area (/m², /km²) and/or as the number of particles per unit water volume (/m³). Therefore, it is necessary to obtain the swept area of the net tow and/or the amount of filtered water volume, as calculated by the following equations:
 - Swept area = net width × tow distance
 - Filtered water volume = (net width × net immersion depth) × tow distance* Net width is the horizontal dimension of the net aperture

Recommendations

- Refer to Section 2.4.4 for the estimation of tow distance. Method, equations and numeric figures used when estimating tow sweep area and filtered water volume should be reported.

2.4.4 Tow distance



Flowmeter (RIGO.No.5571)



Neuston net with flowmeter

Keynotes

- Microplastic abundance at the ocean surface is reported as particle number or weight per unit water volume or unit surface area. Therefore, the filtered water volume or the swept surface area of each net sampling should be estimated by the chosen reporting units.
- Generally, filtered water volume or the swept surface area are obtained by multiplying the tow distance by the net immersion area or the net aperture width respectively. There are three methods for obtaining tow distances:
 - (1) Calculate from ground speed obtained from position information measured by GPS, etc.
 - (2) Calculate from the relative speed of the vessel to seawater (log speed), measured with a current meter.
 - (3) Calculate using the rotation count of a flowmeter installed in the net mouth and its calibration value.

Outcomes of the pilot projects

- Tow distances were measured using all three methods simultaneously and the results were compared. Tow distance calculated using method (1) showed large differences depending on the dominant direction of water flow when compared to methods (2) and (3). Results for methods (2) and (3) were similar to each other.

Recommendations

- Method (3) appeared to generate the most accurate value for estimating the water volume passing through the net both theoretically and experimentally.
- It is recommended that Method (3) be used with a flowmeter set at the net mouth to obtain the tow distance, the density of microplastics per swept area and also density of microplastics per filtered water volume. This is further supported by other guidelines (i.g. GESAMP, 2019). Calibration of the flowmeter is important and necessary. Location/vessel position at the start and end of each tow should be recorded.
- If a flowmeter is not available, it is necessary to estimate sampled water volume using an appropriate tow distance calculation through other alternative methods, such as using speed relative to sea water.

Explanatory Notes

- Earlier studies have reported large differences between tow distances calculated from ground speed and tow distances calculated by a flowmeter (Suaria et al., 2016).
- In CMSM2019, the tow distance obtained from the vessel speed relative to the ground using GPS, the speed of the vessel relative to seawater measured by the flowmeter, and the rotation number and calibration value using a flowmeter, were compared. When comparing distances calculated from the relative speed of the vessel to the seawater (log speed) and distances calculated using a flowmeter, both methods produce similar results. CMSM2019 found there to be no statistically significant difference. However, data obtained using a flowmeter is fundamental, so it is recommended to use the flowmeter as considered by other guidelines (GESAMP, 2019) and discussions of expert meeting.
- On the other hand, a difference was observed when comparing the tow distances obtained from the vessel speed relative to the ground using GPS and calculated using a flowmeter, in some cases (Fig.2-11, left side). It is assumed that tow distance calculated from ground speed may not reflect the actual amount of filtering.
- For this reason, it is desirable to estimate the amount of filtered water by attaching a flowmeter to the net mouth.
- In cases with high waves that may cause the flowmeter to pop above the water surface during towing, it would be desirable to maneuver the vessel to ensure the flowmeter is submerged so that the tow distance can be measured correctly.
- When using a flowmeter, it is necessary to select a model that can accurately measure filtered water distances at different towing speeds. In addition, it is important to ensure that measurements can be conducted accurately at the planned towing speeds before towing.
- Flowmeters should be calibrated in advance. For example, nets could be towed horizontally in a pool equipped with a water flow generator for calibration. Alternatively, a flowmeter could be installed in the net frame without a net and sunk to a certain depth. It is then pulled up to the water surface, and the distance calculated using the flowmeter could be compared with the actual sunken depth.
- When filtered water volume needs to be estimated based on distance measured, for example using GPS and when there is a strong water current in the survey area, the estimation of the sampled distance by adjustment of the filtered water volume against the current direction and speed should be considered (Fig.2-11). However, there were no statistically significant differences (Table 2-6).

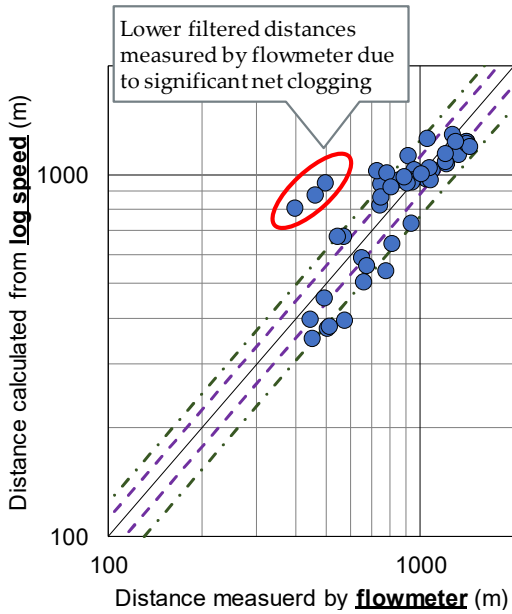

Note 1

- - - : "Average" ± "Standard deviation" of "Proportion"
- . . . : "Average" ± 2 x "Standard deviation" of "Proportion"

$$\text{Proportion} = \frac{\text{Distance calculated from log speed}}{\text{"Distance measured by flowmeter" + "Distance calculated from log speed"}}$$

Note 2: Average of proportion: 0.50, Standard deviation of proportion: 0.069

Fig.2-10. Relationship between tow distance obtained using a flowmeter and distance calculated from log speed in the CMSM2019 survey.

For calculating these data, the tow distance obtained while towing a Neuston net with mesh openings of 0.35 mm was used.

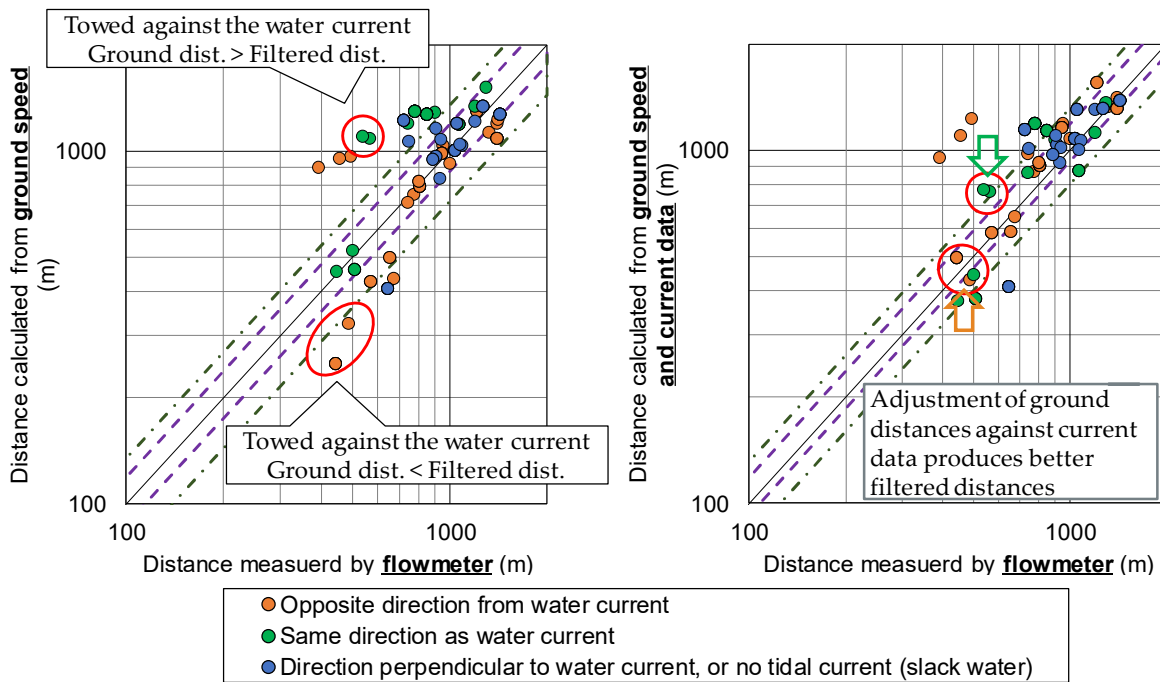

Fig.2-11. Relationship between tow distance obtained using a flowmeter and distance calculated from ground speed using coordinates obtained by GPS in the CMSM2019 survey.

Note 1 - - - : "Average" ± "Standard deviation" of "Proportion"
 - . . . : "Average" ± 2 x "Standard deviation" of "Proportion"

$$\text{Proportion} = \frac{\text{"Distance calculated from ground speed"}}{\text{"Distance measured by flowmeter" + "Distance calculated from ground speed"}}$$

Note 2 Averages and standard deviations of proportion are as follows.

	Distance calculated from ground speed	Distance calculated from ground speed and current data
Average	0.52	0.53
Standard deviation	0.078	0.064

Note 3 Current data measured for Sagami Bay by Japan Coast Guard with short-wave ocean radar used above

Table 2-6. T test results of significant difference in distances between various methods (in CMSM2019).

Proportion' is the ratio of the 'Manta' value to the sum value of 'Neuston' plus 'Manta'.

- (A) Proportion of "Port" vs "Starboard" of distances measured by flowmeter = $\frac{\text{"Port" of distances measured by flowmeter}}{\text{"Port" of distance measured by flowmeter} + \text{"Starboard" of distance measured by flowmeter}}$
- (B) Proportion of "Distance calculated from log speed" vs "Distance measured by flowmeter" = $\frac{\text{"Distance calculated from log speed"}}{\text{"Distance calculated from log speed"} + \text{"Distance measured by flowmeter"}}$
- (C) Proportion of "Distance calculated from ground speed and current data" vs "Distance measured by flowmeter" = $\frac{\text{"Distance calculated from ground speed"}}{\text{"Distance calculated from ground speed"} + \text{"Distance measured by flowmeter"}}$
- (D) Proportion of "Distance calculated from ground speed and current data" vs "Distance measured by flowmeter" = $\frac{\text{"Distance calculated from ground speed and current data"}}{\text{"Distance calculated from ground speed and current data"} + \text{"Distance measured by flowmeter"}}$

	"Port" vs "Starboard" of distances measured by flowmeter (A)	"Distance calculated from log speed" vs "Distance measured by flowmeter" (B)	"Distance calculated from ground speed" vs "Distance measured by flowmeter" (C)			"Distance calculated from ground speed and current data" vs "Distance measured by flowmeter" (D)					
			Opposite direction from water current	Same direction as water current	Direction perpendicular to water current, or no tidal current (slack water)	Opposite direction from water current	Same direction as water current	Direction perpendicular to water current, or no tidal current (slack water)			
Numbers of data	41	47	47	20	12	15	47	20	12	15	
Average of proportion	0.50	0.50	0.52	0.49	0.57	0.51	0.53	0.54	0.52	0.52	
Standard deviation	0.033	0.059	0.078	0.088	0.062	0.053	0.064	0.074	0.058	0.048	
T test	T value	-	-0.019	-1.189	0.607	-4.817	-0.757	-2.355	-3.048	-1.134	-1.222
	P value	-	0.49	0.12	0.27	0.0000067	0.23	0.010	0.0017	0.13	0.11

2.4.5 Tow position

Keynotes

- In general, a sampling net is towed at the side of a vessel. In some cases, it may be towed at the stern provided it is positioned to avoid the wake of the vessel.

Outcomes of the pilot projects

- Effect of tow position on sample collection was tested using nets towed at one-vessel length and two-vessel length behind the stern. There was no statistically significant difference in the density of microplastic samples collected at one-vessel length behind the stern of the vessel and those collected at its side. On the other hand, there was a statistically significant difference between the particles collected at two-vessel length behind the stern of a vessel and those collected at its side.
- Therefore, it is very difficult to correct particle densities obtained at the stern by sampling at the sides of the vessel.

Recommendations

- It is desirable to conduct sampling at the side of the vessel with less influence from turbulence caused by its wake.

Explanatory Notes

- Nets are generally positioned on either side of the vessel (port/starboard) or at the stern. In CMSM2018, densities of microplastics collected were compared by towing Neuston nets at the port, starboard and stern simultaneously.
- With the net set at the stern (vessel size 16 m, rope length 20 m, towed directly behind the hull), the density of microplastics >1 mm was less than that obtained by collecting at the vessel side, suggesting the influence of vertical mixing of microplastics caused turbulence from the wake, etc. (Fig.2-12)
- Furthermore, in CMSM2019, particle collection was tested further using nets towed at one-vessel length (12 m) and two-vessel length (24 m) behind the stern. There was no statistically significant difference in the density of microplastics collected at 12 m behind the stern of the vessel and those collected at its side. However, there was a statistically significant difference (p value is 0.001) between the particles collected at 24 m behind the stern of a vessel and those collected at its side (Table 2-7).
- Fewer particles captured by the stern tows could be attributed to the size & shape of a boat, its speed & position of its propeller, meteorological & hydrographic conditions, and distributions of particles.
- Since it would be very difficult to adjust the particle densities obtained by the stern tows to those for the side tows, particles should be collected by the side tows.

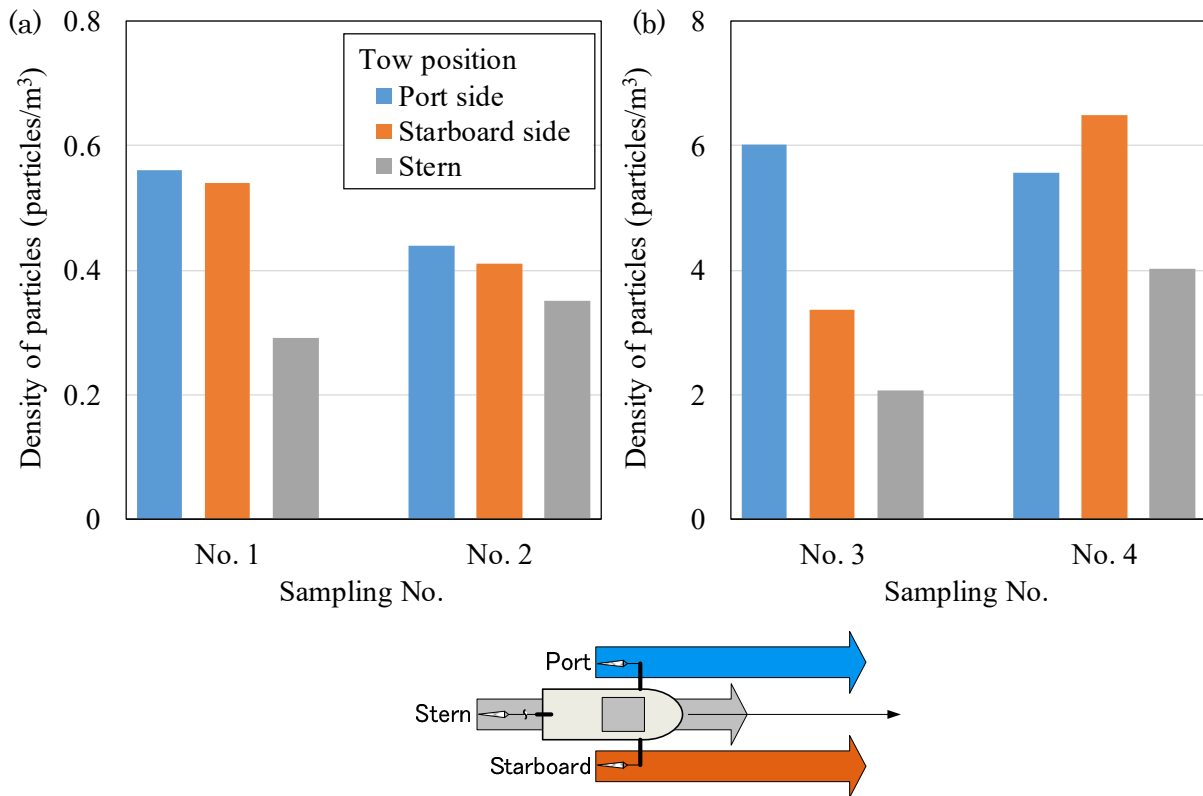

Fig.2-12. Particle density comparisons depending on tow position (In CMSM2018).

These are divided into two figures according to density of particles due to wide disparities, reflected in the larger scale of the Y-axis in (b): (a) 0-0.8 particles/m³, and (b) 0-8 particles/m³.

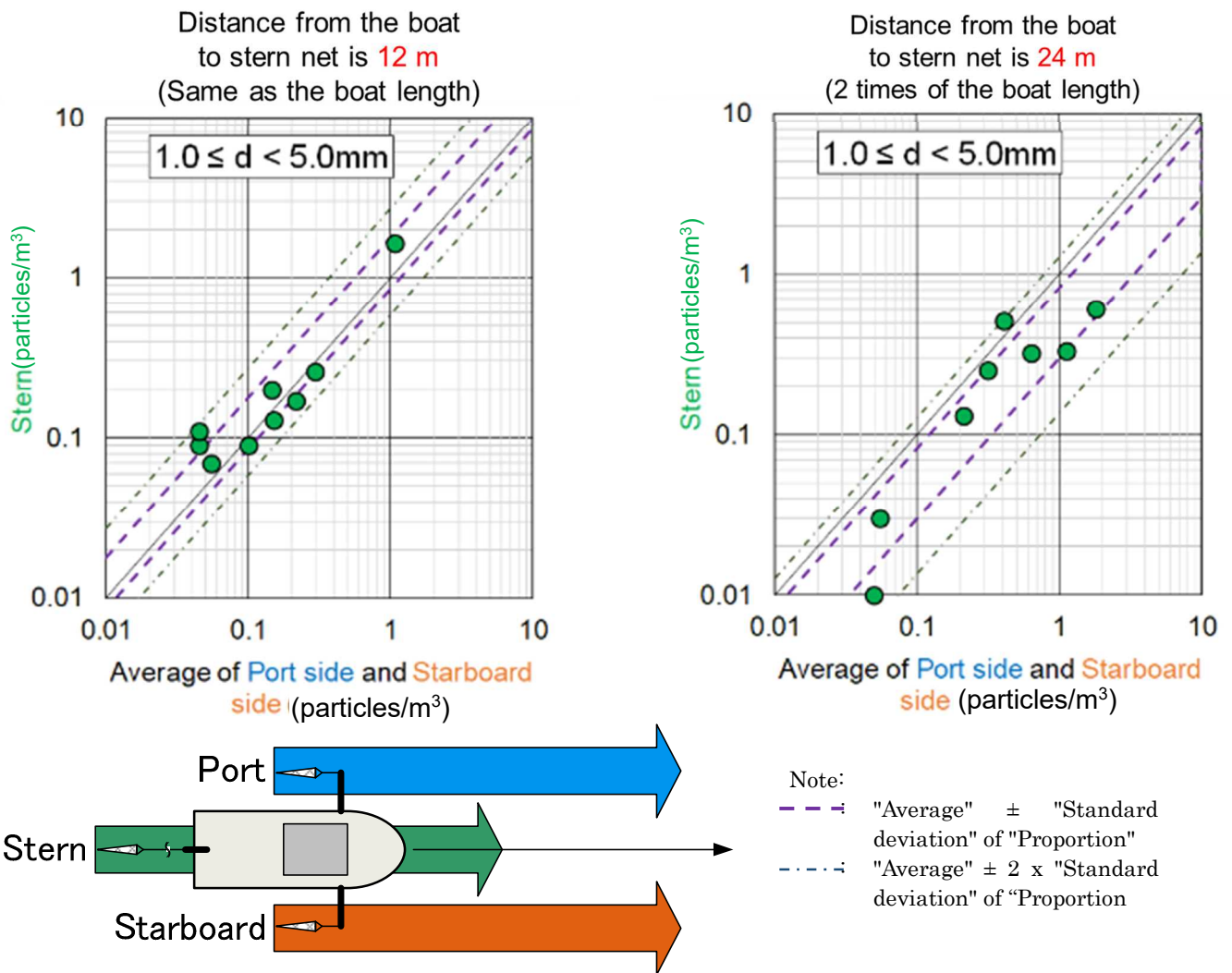

Fig. 2-13. Particle density comparisons depending on tow position (In CMSM2019).

Proportion is as follow.

$$\text{Proportion} = \frac{\text{Density of "Stern"}}{\text{Density of "Stern"} + \frac{\text{Density of "Port"} + \text{Density of "Starboard"}}{2}}$$

Averages and standard deviations of proportion are as follows.

	Distance from boat to stern net of 12 m (same as the boat length)	Distance from boat to stern net of 24 m (two boat length)
Average	0.55	0.31
Standard deviation	0.09	0.12

Table 2-7. T test results of significant difference in the density of microplastics between the particles collected at the stern of the vessel and those collected at its side. (in CMSM2019).

"Prop." is Proportion. Prop. Port vs starboard and Prop. Stern vs side are as follows.

$$\text{Prop. Port vs starboard} = \frac{\text{Density of "Port"}}{\text{Density of "Port" + Density of "Starboard"}}$$

$$\text{Prop. Stern vs side} = \frac{\text{Density of "Stern"}}{\text{Density of "Stern" + } \frac{\text{Density of "Port" + Density of "Starboard"}}{2}}$$

		Proportion		
		Port vs starboard	Stern vs side	
			Distance from boat to stern net of 12 m (same as the boat length)	Distance from boat to stern net of 24 m (two boat length)
Numbers of data		20	9	8
Average of proportion		0.53	0.55	0.34
Standard deviation		0.13	0.10	0.12
T test	T value		-0.40	-3.52
	P value		0.34	0.001

2.4.6 Net immersion depth

Keynotes

- Net immersion depths have been recorded between 10 cm and 100 cm. Manta net immersion depth is measured as the height of the net's mouth, whereas a Neuston net is often set at about 1/2 to 3/4 of the height of the net's mouth.
- Recording immersion depth of the net during sampling is important as the area of the net mouth under the sea surface is multiplied by the tow distance to estimate the filtered water volume.

Outcomes of the pilot projects

- The Manta net tended to jump and skip above the sea surface when the waves were rough.
- There were cases when the Neuston net sank over time as a large amount of floating matter was collected and maintaining a constant immersion depth was considered difficult when the waves were rough or there was an abundance of drifting seaweed, etc.
- The immersion depth was kept constant by installing the floats with enough buoyancy.

Recommendations

- It is necessary to tow the net in a way that keeps the immersion depth constant. Measures such as attaching a moderate weight, adjusting the length of the tow rope and avoiding high wave conditions that may cause the Manta net to jump and skip on the water surface are recommended.
- This is particularly important when towing a Neuston net and in conditions when the immersion depth cannot be controlled effectively due to large amounts of floating matter. Periodically recording the net immersion depth during each sampling run is considered effective for accurately calculating the filtered water volume.

Explanatory Notes

- Data on net immersion depth at the time of towing is required for accurate calculation of the net sampling area and filtered water volume. It is necessary to keep the immersion depth as constant as possible. It is also important to clarify the depth from the surface at samples are collected.
- In CMSM2018 and CMSM2019, Manta nets were observed to jump off the sea surface when wind and waves were present, making them difficult to tow. Although it is possible to make some adjustments by attaching a heavier weight to the net mouth or by changing the direction of the net relative to the wind and current, accurate sampling is assumed to be difficult if the wind is strong and waves are high.
- When a Neuston net was used, there was a greater change in net immersion depth when large pieces of floating matter (seaweed, jellyfish, etc.) were caught in the net, especially when a net with finer mesh openings was used or large amounts of plankton were caught. In this case, the change in net immersion depth could not be reversed even if the length of the rope was adjusted.

- Therefore, in surveys using a Neuston net, attention is required when comparing results. Significant changes in immersion depth can be expected when many large pieces of floating matter are also present. This may also reduce filtering efficiency.
- In CMSM2019, the Neuston net was kept at constant immersion depth using floats attached to the frame (Fig.2-15). The buoyancy of those floats was about 40 kg when the mouth of the Neuston net of W:75 cm x H:75 cm x L:3 m was half immersed (immersion depth: 37.5 cm).
- When towing in a sea area with a lot of floating matter, it is helpful to set a marker at the net mouth to indicate the immersion depth, and record the immersion depth at the net mouth by the video camera or by taking photographs of the net mouth periodically (Fig.2-14).

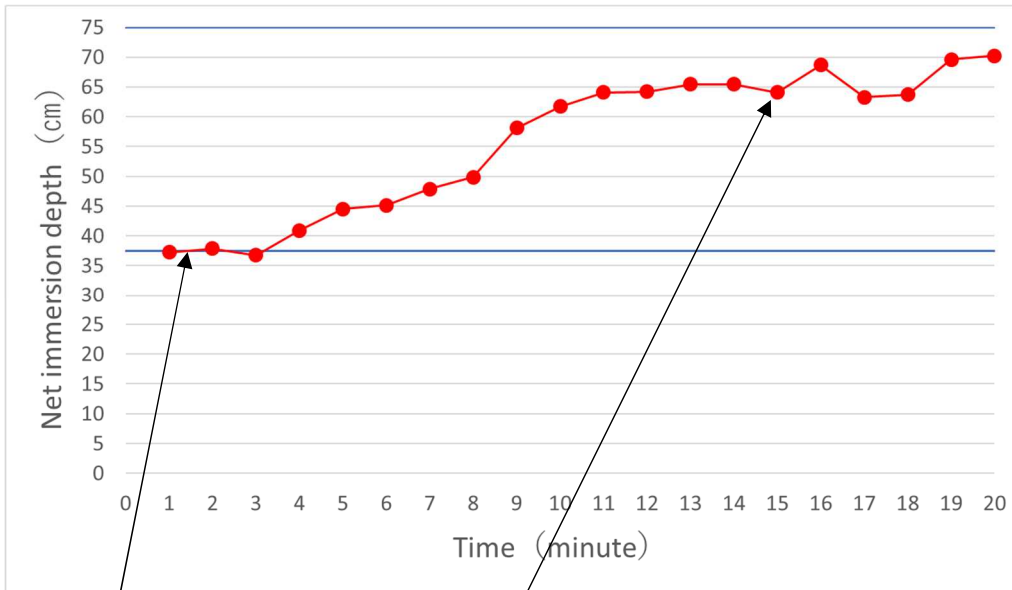

Immediately after tow starts (net immersion depth normal)



13 min. after tow starts (net immersion depth increased).



Sample inside net with increased immersion depth (a large amount of sea buckthorn (*Zostera marina*) has been caught).

(May 18, Tow No. 5, starboard side)

Fig.2-14. Chronological changes in net immersion depth obtained through image analysis.



Fig.2-15. Adjustment of immersion depth of the Neuston net by attaching appropriate floats.

2.5 Metadata

Keynotes

- In general, wind speed and wave height have a large effect on the microplastic density in the ocean surface layer (e.g., Reisser et al., 2015, Suaria et al., 2016).

Outcomes of the pilot projects

- Microplastic particle density at the ocean surface decreased when wind speed and wave height increased.
- High density of microplastics were observed at the ocean surface when salinity decreased (Fig.2-16). Sampling in water bodies that were affected by river water is a possible cause.

Recommendations

- To ensure comparability, metadata for each sampling event should be recorded through in situ observations or onboard instruments where possible. Data required include the time of day and date (to account for seasonality), as well as environmental variables (e.g., weather conditions, wind speed, wind direction, wave height, Beaufort scale index, chlorophyll, fluorescence, salinity etc.) and additional sampling parameters. For more details, refer to Chapter 4 (p. 66).

Explanatory Notes

- Start position coordinates and specific method information (such as tow time, tow speed, the rotation number of the flowmeter, net position and net immersion depth), must be recorded.
- A nearly ten-fold difference in microplastic density at the ocean surface was observed over a relatively short time (about 20 to 30 min.) and a small spatial scale (distance of about 100 to 500 m) in CMSM2018. Some correlations were observed when chronological changes in density were compared with physical environment data (wind and waves) and water quality data (water temperature and salinity). Specifically, as wind speed and wave height increased, the density of microplastics tended to decrease (see Section 2.2, Fig.2-2), and when salinity decreased the microplastic density tended to increase (Fig.2-16).
- It is necessary to record **wind direction** and **wave height** before and after each sample. Adverse weather conditions in the days prior to the survey may affect microplastic densities at the ocean surface.
- There were cases in which the density of microplastics may have increased due to an influx of river water in CMSM2018. When rain is observed shortly before or on the day of the survey, data on **precipitation** would be beneficial. River flows are strongly influenced by rainfall which may influence both freshwater input and salinity and consequently floating microplastics.
- The influence of **tidal current direction** and **flow rate** on microplastic collection results is not clear, but it is beneficial to record these as they are useful in considering the influence of loads from land areas via rivers. If the vessel does not have a current meter, it is recommended to record survey conditions using publicly available oceanographic data for the surveyed area.
- As water temperature and salinity are generally characteristic for each water mass, water temperature and salinity are considered useful information in confirming whether the

properties of the water mass have changed between tows, especially in coastal zones that are easily affected by rivers and tides.

- In addition, there are indications that it is possible to minimize variance in collection results by towing in a way that keeps the direction of the net relative to the wind direction constantly perpendicular. It would be desirable to record the direction of the net relative to the wind direction and ocean current.
- The presence of floating matter captured in the net can also be recorded.
- Variables may differ from sampling cruise to sampling cruise, or even from sample to sample. If it is possible to average all variables during a sampling event, e.g., 20-minute tow, this is preferable over only recording the information at the beginning and the end of each tow.

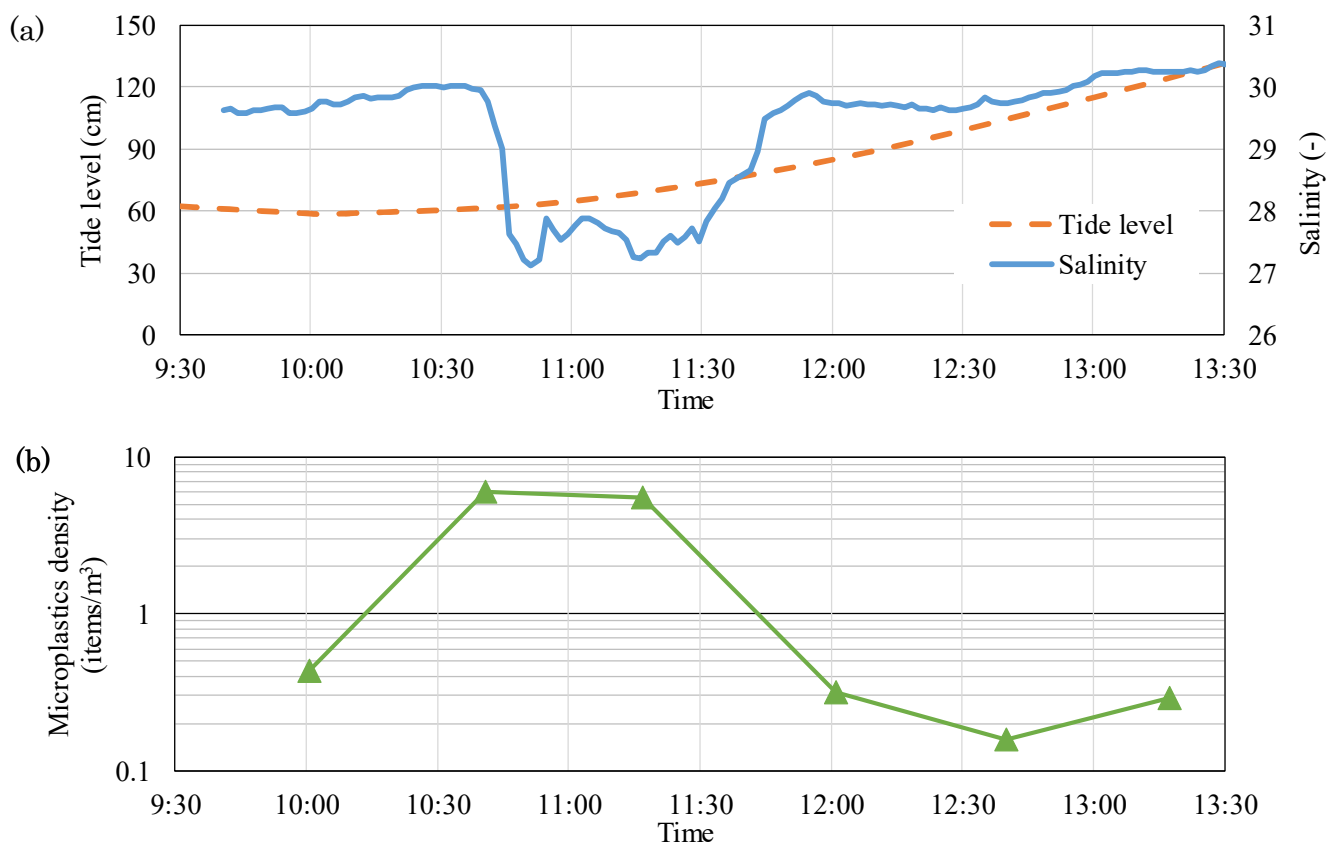

Fig.2-16. Tide level and salinity (a) and chronological changes in microplastic density (b).
Microplastic density plotted at the time of tow start.

2.6 Field sample blanks

Keynotes

- Generally, in the net sampling of microplastics, the net is cleaned thoroughly from its outside before the start of a sampling run to ensure no plastic particles are left inside the net. The influence of plastic particles remaining in the net on the survey results can be significant, especially in sea areas where the number of sampled microplastics is relatively small. Therefore, cleaning just before each sampling run is particularly important to prevent plastic particles from clothing, equipment, the vessel's paint, etc. from entering the net and affecting the results.

Outcomes of the pilot projects

- Blank tests were carried out for a research vessel eight times in a similar manner to those reported (GESAMP, 2019) by washing the net before towing, comparable to washing after towing, by hanging the net with a crane and pouring pumped sea water from the outside the net, then counting the microplastics in the cod end. Two microplastic particles were observed on average.
- A similar blank test was carried out for a net that had been kept in a natural fiber bag for a long time after being thorough cleaning at the end of a survey. This specific net was observed to contain many particles, indicating that contamination may occur during storage.
- Blank tests for the fishing boat was also carried out, and the results clearly identified particles of paint and cushioning material fragments generated from the fishing boat.

Recommendations

- Nets should be washed thoroughly before each sampling run due to the risk of contamination during storage.
- It is necessary to take extra care to avoid contamination with regard to on-board operations and the storage of nets.
- A field blank test is recommended to be conducted for at least one of several nets to be used for a survey, as it can confirm whether sampling procedures such as washing have been carried out properly without contamination. When towing multiple times, it would be desirable to periodically conduct blank tests to ensure particle contamination has been sufficiently controlled.

Explanatory Notes

- To understand how accurately procedures such as washing are carried out, implementing a blank test for at least one out of several nets is recommended.
- Generally, when net towing is completed, the rotation number of the flow meter is first recorded, then the net is hung using a crane or pulley and cleaned thoroughly from the outside. For washing the net, it is common to use sea water pumped up using a pump installed aboard the vessel. When doing so, care needs to be taken to avoid having the sea water enter the net via the mouth.

- In CMSM2018, field blank sampling was conducted by washing unused nets in the same manner as for sampling, and on average two plastic particles (ranging from 0 to 5) were confirmed.
- Confirmed particles were all sufficiently shorter in shortest length than the mesh openings (0.35 mm), and the composition of the material also differed from those obtained in the surveyed surface layer. Therefore, it is assumed that plastic particles smaller than the mesh openings do not cause contamination when washing from the outside of the net.
- Also, when a net that had been stored for a long time was used in a blank test without washing immediately before use, more particles were confirmed than when the net was washed in advance. This net had been thoroughly cleaned after the most recent past survey and stored in a natural fiber bag.
- Before using a net that has been stored for a long time, it would be desirable to wash it again, even if it was thoroughly washed after the previous survey, taking into consideration the possibility of contamination with plastic particles during storage.
- The number of particles collected each day in the survey area was around 100 to 2,000 particles, so the several plastic particles collected in the blank test were considered not to have a significant influence on the survey results (above the limit of detection, LOD). However, a higher level of plastic particle contamination (24 pieces) was confirmed in a net stored for a long time, so the influence cannot be ignored when sampling in sea areas where the quantities collected are small. Therefore, it is necessary to pay attention and avoid contamination as the survey is conducted.
- In addition, a survey was conducted in CMSM2019 using fishing boat (other than vessels specified to research), and found particles that may be caused by paints or cushioning materials of a vessel.
- When particles confirmed as plastic were found in the blank sample, a high proportion of particles were vinyl chloride, polystyrene and polyurethane. These materials are rarely found in the survey samples. Therefore, it is assumed that the net had been contaminated not only from its washing, but also from tape used to fix equipment and the vessel's buoy and paint. For surveys, it is advisable to pay attention to plastic products on the vessel and take measures to prevent contamination, such as keeping them as far away as possible from places where samples are processed.

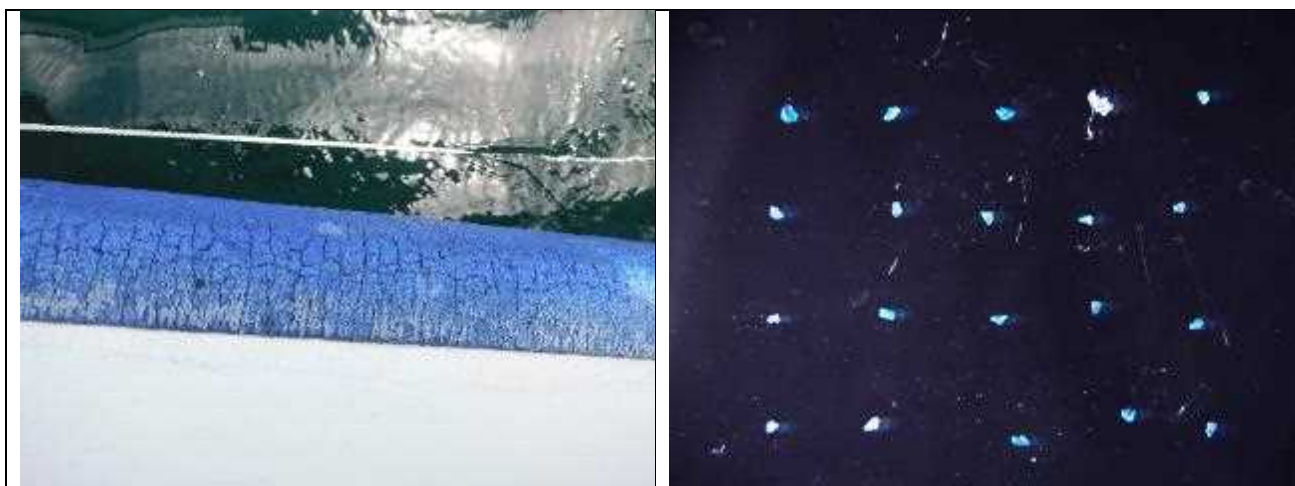

Fig.2-17. (A) Deterioration of boats

(B) corresponding fragments detected in field blank

3. Laboratory analysis

3.1 Outline

- In general, analysis of samples that include microplastics obtained by trawling a net through the ocean surface layer is carried out in the following order: pretreatment (separation of non-plastic material other than microplastics), isolation of microplastics, counting and measurement, and material identification. Depending on the purpose of the study, their weight may also be measured.
- The order of the pretreatment process, i.e. density separation, chemical treatment, biological digestion and sample splitting, may differ depending on the purpose of the survey and the state of the sample.
- Prior to all analytical processes, fractionation of the samples, including non-plastic material, is sometimes performed by sifting through various sizes sieves.

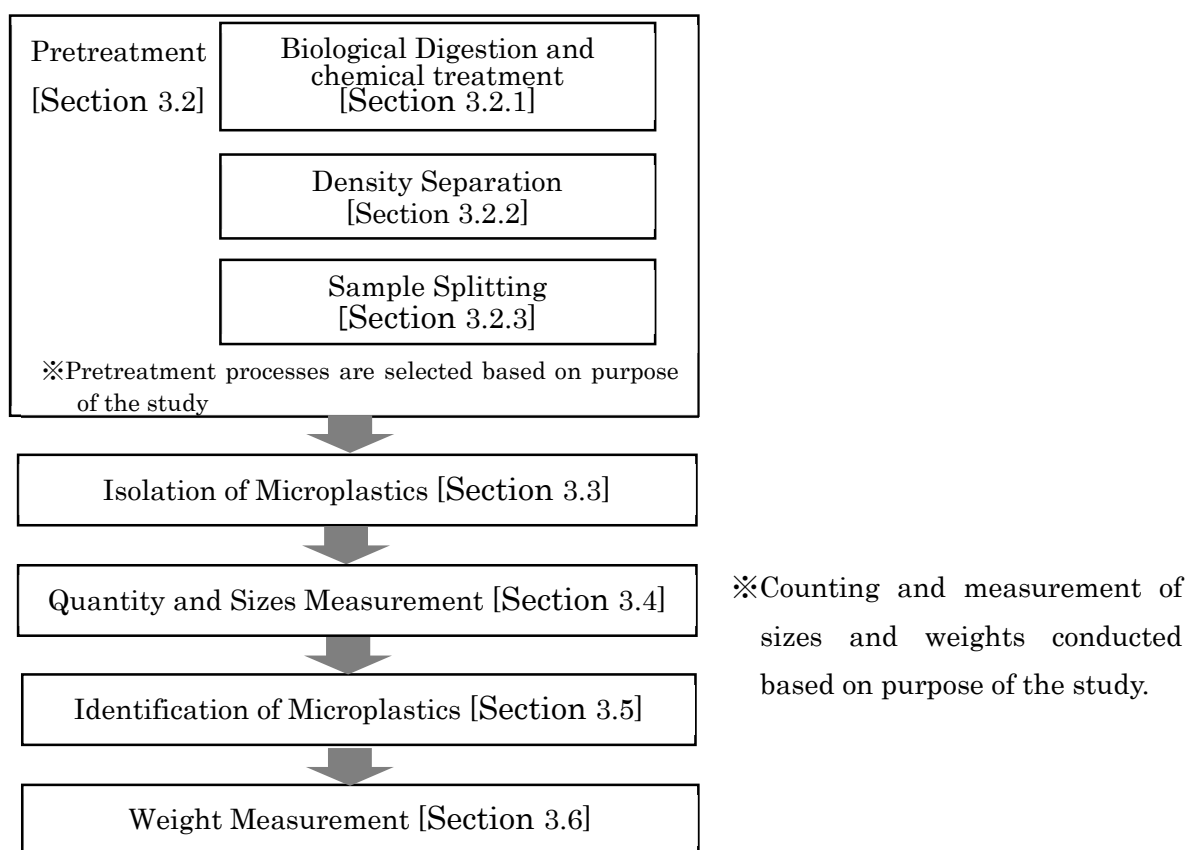

Fig.3-1. General flow of microplastic analysis.

- When comparing the densities of microplastics obtained through laboratory procedures, care should be taken to note which method was used, as oversight or loss of microplastics may occur depending on the pretreatment or separation methods. The proficiency level of the analysts may also be a source of error.
- Before preparation of these Guidelines, an international collaborative analysis with the participation of 12 laboratories from 10 countries (ILC: Inter Laboratory Comparison) in 2017. The ILC used standard samples to ascertain the extent of variation in results depending on the various analytical methods used. Each of the standard samples contained plastic particles of the same number, size and weight, and some non-plastic material (plankton, seashells, wood pieces, crustacean shells, etc.).
- Two samples were sent to each laboratory, one with a large amount of microplastics and non-plastic material simulating a sample from an inner bay, and the other with few microplastics and non-plastic materials, simulating a sample from the outer ocean.
- These samples were analyzed according to the analytical methods of each laboratory, and the results and analytical procedures used were reported to the secretariat. The differences between the results reported from each laboratory and the design value of the standard samples were compared and discussed in terms of whether the differences were systematic.
- With regards to harmonization, recommendations and points to be noted in each analytical process are introduced in this chapter based on the results of the ILC.
- These Guidelines focus on the microplastics present in sea water and do not cover the analysis of microplastics taken in by lower organisms such as plankton.
- A part of the results of the ILC has been published in a scientific journal (Isobe et al., 2019).

3.2 Preprocessing for analysis

- Samples obtained by net towing contain various natural particles as well as plastic particles. Removing the non-plastic particles through pretreatment, improves the accuracy of subsequent processing for plastic particles such as isolation, material identification, counting and weighing.
- For that reason, pretreatment may be performed when sampled particles include non-plastic material.
- Fractionation of the samples, including non-plastic material, can be performed by sifting through sieves of various sizes is sometimes performed before pretreatment.
- Pretreatment methods include density separation, mainly to remove inorganic particles, and digestion of organism-derived organic substances by oxidation, hydrolysis or enzymatic reactions.
- When there are many plastic particles and/or non-plastic particles per sample, the sample may be sub-sampled to reduce the amount of counting, measuring and other work at the time of analysis.
- During the ILC, nine out of the 12 laboratories conducted pretreatment; three laboratories conducted only density separation, two conducted only digestion of organic matter, and four carried out both pretreatments. Sample splitting was not conducted at any of the laboratories.

3.2.1 Biological digestion and chemical treatment

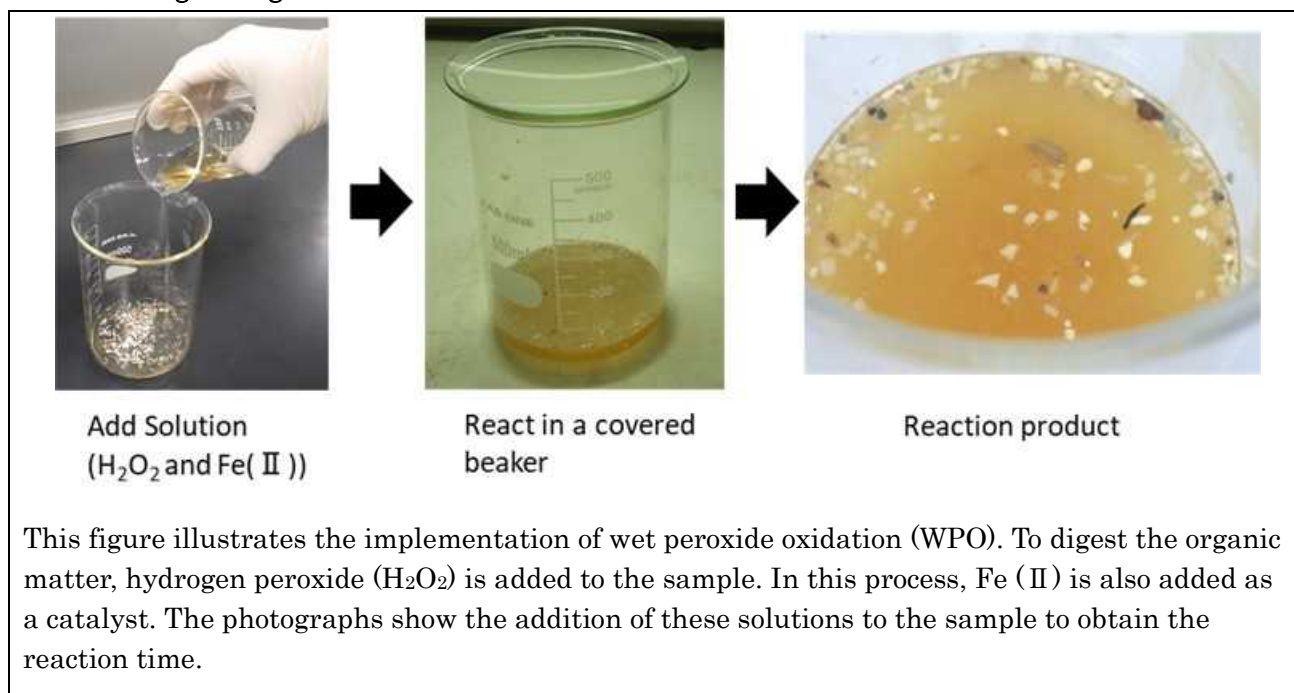

Keynotes

- As described in Section 2.2 of the Guidelines, sampling in sea areas where the density of non-plastic material (including natural-organic matter) is high should be avoided where possible.
- When there are many non-plastic materials such as plankton (in the sample), pretreatment to digest organic substances with chemicals or enzymes is performed in many cases to remove the non-plastic material as well as biofilms that have formed on the surface of the sampled plastic particles. Here the aim is to minimize the possibility of misidentifying plastic particles, improving the accuracy of the isolation process and overall work efficiency. If improperly conducted, however, it may lead to deterioration (deformation and/or weight reduction) of plastic particles from chemicals added or from heating.
- The purpose of digesting organic substances is not limited to the removal of non-plastic material to simplify subsequent processing but may also include analyzing microplastics ingested by organisms in the lower trophic levels such as plankton –although the latter purpose is not covered by the Guidelines.
- Digestion of organic substances is effective when biofilms are formed on the surfaces of plastics and non-plastic material in the sample to the extent that they may interfere with weight measurement and material identification using spectral optical instruments.
- It should be noted that the size of microplastics incorporated into organisms in the lower trophic levels, such as plankton is often in the order of 10 µm (Botterell et al., 2018).

Outcomes of the pilot projects

- In the ILC, there was no systematic difference in the measurement results of plastic particles (larger than 1 mm and less than 5 mm) between the laboratories that performed organic matter

digestion to those laboratories which did not. For particles < 1 mm, the results for the number and weight of particles were underestimated by all of the laboratories but the values obtained by laboratories performing digestion treatments tended to be closer to the original value.

- There was one laboratory conducting digestion that was unable to measure the number of particles correctly because the particles aggregated due to biological residue caused by insufficient digestion.

Recommendations

- From the viewpoint of harmonizing monitoring methods for particle density of particles larger than 1 mm and less than 5 mm in size, it is not always necessary to digest organic matter as a pretreatment.
- On the other hand, when analyzing particles less than 1 mm in size, it would be preferable to digest the organic substances to obtain more accurate analytical results.

Explanatory Notes

- Digestion is an effective method when sampling is performed where there are many organic substances. Digesting organic matter can be performed through oxidation, hydrolysis or enzymatic reactions to make separation of plastic particles easier.
- Removing biofilms formed on the surface of plastic particles or non-plastic material makes material identification by spectral optical instruments more accurate (see Section 3.5).
- Plastics can deteriorate when strong acids are used to digest organic substances (e.g., Miller et al., 2017; Hurley et al., 2018; GESAMP 2019).
- In the ILC, six out of the 12 laboratories conducted organic matter digestion as a pretreatment: among these, three laboratories conducted digestion using hydrogen peroxide and divalent iron solvent (H_2O_2 , Fe^{2+}), one laboratory used only hydrogen peroxide (H_2O_2), one laboratory conducted alkaline digestion using potassium hydroxide (KOH), and one laboratory conducted biochemical digestion using corolase enzyme. The advantages and disadvantages of various biological digestions and chemical treatments are shown in Table 3-1.
- When comparing errors in the measurement results between laboratories that conducted organic substance digestion and laboratories that did not, there was no systematically significant difference in particle quantity measurement results. Consequently, from the viewpoint of harmonization, microplastic measurement results can be compared regardless of whether digestion was performed or not.
- It should be noted that in the ILC, there was a case in which aggregation of particles occurred. This was observed because of insufficient digestion and remnant biological residue.
- Among the particle number and weight measurements in the ILC, the results for particles of less than 1 mm among laboratories that did not conduct digestion tended to be underestimated compared to the design value.

- Laboratories using the digestion of organic substances reported more accurate values for particles <1 mm. It is assumed that digestion makes it easier to isolating plastics.
- When conducting digestion, depending on the purpose and equipment of the study, as well as the state of non-plastic material in the sample, care should be taken to select conditions that do not cause deterioration of the plastics and avoid influence from the digested biological residue (appropriate reagents, temperatures, digestion times, etc.).
- Previous study has suggested paying attention to temperature condition during laboratory analysis. Alfonso et al., (2021) assessed the microplastics' weight, size, and polymer changes under different digestion techniques and suggested that using 40 °C for 72 hours prevails all polymer from size changes. It is also mentioned that any method applying high temperature damages microplastics.

Table 3-1. Advantages and disadvantages of various biological digestions and chemical treatments (reproduced from GESAMP, 2019).

Purification method	Advantages	Disadvantages	Reference
Oxidative digestion	<ul style="list-style-type: none"> • Inexpensive 	<ul style="list-style-type: none"> • Temperature needs to be controlled • Several applications may be needed 	Masura et al. (2015)
Acid digestion	<ul style="list-style-type: none"> • Rapid (24 h) 	<ul style="list-style-type: none"> • Can attack some polymers 	Claessens et al. (2013)
Alkaline digestion	<ul style="list-style-type: none"> • Effective • Minimal damage to most polymers 	<ul style="list-style-type: none"> • Damages cellulose acetate 	Dehaut et al. (2016)
Enzymatic digestion	<ul style="list-style-type: none"> • Effective • Minimal damage to most polymers 	<ul style="list-style-type: none"> • Time-consuming (several days) 	Löder et al. (2017)

3.2.2 Density separation



Density separators

Density separation is often performed by pouring the sample and a dense solvent into a funnel or a separating funnel.



Floating plastic particles in a density separator
Plastics with lower specific gravity than the solvent float on the surface.

Keynotes

- Density separation may be performed as a pretreatment to remove non-plastic material in the sample. This step is more commonly performed for sediment sample analysis.

Outcomes of the pilot projects

- There was no systematic difference in analytical results among laboratories that performed density separation on the standard samples and laboratories that did not perform density separation.

Recommendations

- In cases where there is a lot of non-plastic material, density separation would be effective as it enables efficient separation of plastic particles, but from the viewpoint of harmonizing the methods of monitoring microplastics at the ocean surface, it is not necessarily required.

Explanatory Note

- Density separation is an effective method of fractionating low-density plastic particles and high-density natural particles of inorganic matter.
- In general, density separation is conducted by mixing the sample into a solution with a higher specific gravity than that estimated for the collected plastic particles, letting high-density inorganic substances settle out and recovering and fractionating the floating low-density plastic particles. Commonly employed solutions for density separation of microplastics are shown in Table 3-2.
- Density separation is a particularly effective process for measuring microplastics in bottom and coastal sediment samples that include heavy materials such as sand, seashells, etc. It is not necessarily a common practice in analyzing floating microplastics samples collected with nets at the ocean surface, but may be required when there are lots of plankton.

- In the ILC, density separation was carried out at seven out of the 12 laboratories, using aqueous solutions of sodium chloride (NaCl) or sodium metatungstate hydrate (Na₂WO₄) for the separation.
- There were no systematically significant differences in the measurement results between laboratories that did or did not perform density separation. Consequently, from the viewpoint of harmonization, the results of surface layer microplastic density per filtered water volume can be compared for microplastics that are 1 mm or larger and less than 5 mm regardless of whether density separation was performed or not.

Table 3-2. Solutions commonly used for the density separation of microplastics (reproduced from GESAMP, 2019)

Salt	Density (g cm ⁻³)	Reference
Sodium Chloride (NaCl)	1.2	Hidalgo-Ruz et al. 2012
Sodium Polytungstate (PST)	1.4	Hidalgo-Ruz et al. 2012
Sodium Iodide (NaI)	1.6	Claessens et al. 2013
Zinc Chloride (ZnCl ₂)	1.7	Imhof et al. 2012
	1.6	Zobkov & Esiukova, 2017.

3.2.3 Sample splitting



Folsom splitter



Use of Folsom splitter
Splitter is moved back and forth to mix thoroughly, then the sample is divided.

Keynotes

- Sample splitting before counting is often performed in analyses for zooplankton, especially where the quantities sampled are large. It is not common in the analyses of microplastics.

Outcomes of the pilot projects

- The standard samples and samples obtained in actual sea areas were divided with a splitter (Folsom splitter) and measured. The estimated values of the total number of particles from the divided samples had about $\pm 10\%$ error with respect to the total measured number of particles. When the splitting was repeated, a tendency for the error to increase was observed.

Recommendations

- Using a splitter may be effective when the number of particles in one sample is large (e.g., when it exceeds 1,000 or so) or when there are time or personnel constraints, keeping in mind that a certain level of error is expected.

Explanatory Notes

- In a small proportion of analyses for zooplankton and microplastics, the samples are divided and only a part of each sample is analyzed to improve the efficiency of the analysis. The samples were divided using a Folsom splitter, known for its high splitting accuracy (Guelpen et al., 1982) in some cases (Fossi et al., 2016, Di Mauro et al., 2017).
- After confirming no loss of particles when using a splitter on the standard samples in ILC, a splitter (Folsom splitter) was used in a trial with samples obtained in an actual sea area.
- The samples obtained in the actual sea area were divided using the splitter and the number of particles was counted. Compared to a sample for which all particles were counted, the error was about $\pm 10\%$ for a sample divided into two using the splitter once, and $\pm 20\%$ for a sample divided into four using the splitter twice. It is assumed that almost the same level of accuracy was achieved in the splitting process for plankton (Guelpen et al., 1982).
- As described above, dividing microplastic samples using a splitter is an effective means of

improving efficiency when large amounts of samples need to be divided and time is limited, or when analyses need to be conducted with limited human resources or time, keeping in mind that some error is expected. When dividing the sample with a splitter, it is necessary to stir it thoroughly and sufficiently wash and collect the sample sticking to the wall of the splitter. It would also be desirable to verify the degree of error for the sum of measurements obtained from each portion of a sample divided by the splitter compared to the measurement of the original sample.

Table 3-3. Error due to use of splitter.

Note: ' N_{total} ' indicates the total number of microplastics in all sub-samples.
 ' N_{sub} ' indicates the number of microplastics in each of the sub-samples.
 'sub-R' indicates one of the sub-samples split into two.
 'sub-LR' and 'sub-LL' indicate one of the sub-samples split into four.
 'R' indicates the right side of the splitter, 'L' indicates the left side of the splitter.
 'Coefficient of variation: (standard deviation) / (average)

		Sample Number										Average (Coefficient of Variation)
		1	2	3	4	5	6	7	8	9	10	
N_{total}		873	929	297	537	732	656	1,141	1,505	1,226	1,434	933
$N_{sub \times 2} / N_{total}$	sub-R	1.03	0.90	0.88	0.86	0.99	0.88	1.01	0.83	1.02	0.85	0.92 (8%)
$N_{sub \times 4} / N_{total}$	sub-LR	1.20	1.15	0.93	1.23	0.90	0.88	0.94	1.41	0.87	1.15	1.07 (17%)
	sub-LL	0.75	1.04	1.32	1.06	1.11	1.35	1.04	0.94	1.09	1.16	1.09 (15%)

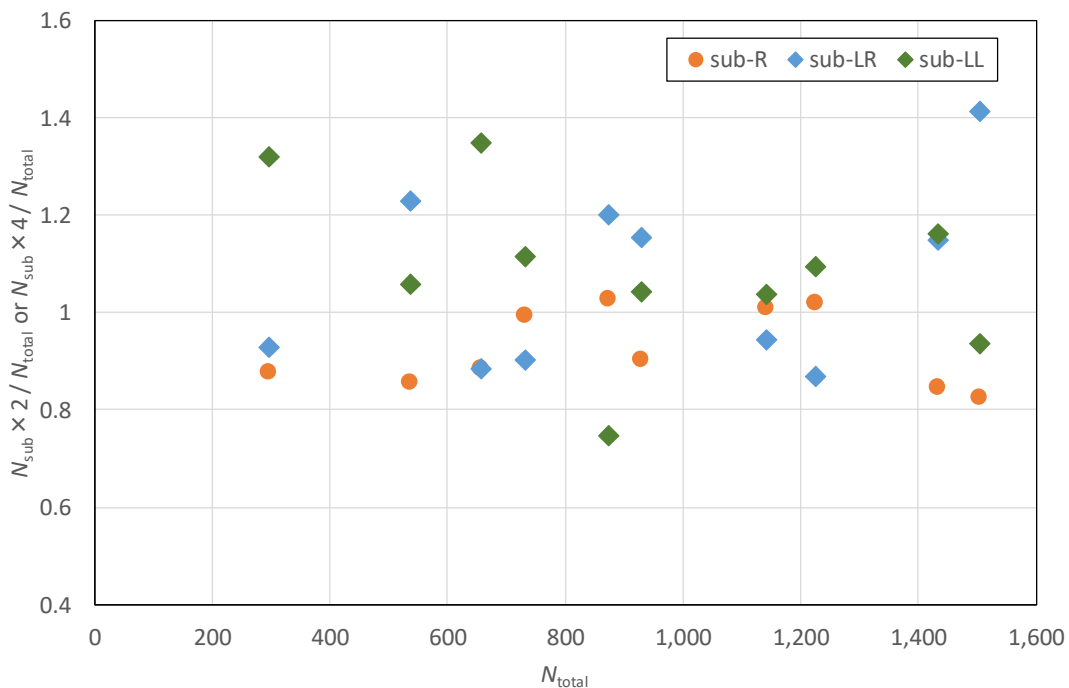

Fig. 3-2. Ratios of number of particles estimated from the result of counting divided samples to the number of particles when the total quantity was counted.

3.3 Isolation of microplastic



Isolation process

To separate microplastics, it is common to pick them out manually under a stereomicroscope.

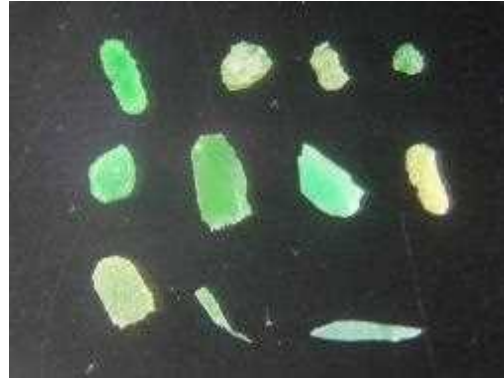

Microplastics on a petri dish

Microplastics collected in CMSM 2018.

Keynotes

- Particle isolation is an important process that greatly affects the accuracy of the microplastic analysis.
- There are several methods of separating plastic particles from a sample, such as isolation of plastic particles out after fractionating the sample by size using sieves of various sieve mesh opening sizes such as 5 mm, 1 mm, and 0.3 mm, and picking the plastic particles from the filter paper after directly filtering the sample. Stereomicroscopes are commonly used to facilitate this.

Outcomes of the pilot projects

- Despite the use of stereomicroscopes by all the laboratories for hand-picking, the quantities of separated plastic particles <1 mm from the standard samples were underestimated by 40 to 80%, and the variance in reported results among the laboratories was also large. This was thought to have resulted from the loss of particles during the pretreatment process as well as incomplete particle isolation.

Recommendations

- To obtain fairly accurate results, conducting the picking process carefully is recommended even when a stereomicroscope is used, and exerting caution to avoid losing particles in pretreatment. Be especially careful not to overlook particles smaller than 1 mm.
- Reporting should separate particles by size, specifically for those smaller than 1 mm and for particles larger than 1 mm to maintain comparability based on sampling errors related to mesh size.

Explanatory Notes

- The accuracy of particle isolation greatly affects microplastic analysis results, as plastic particles picked out from the sample, whether pretreated or not, are used for subsequent measurement and analysis.
- Particle fractionation using sieves with various mesh openings, such as 5 mm, 1 mm, 0.3 mm may be carried out before pretreatment when the samples include non-plastic materials.
- In the ILC, many laboratories filtered the samples through sieves with mesh openings of 5 mm or 0.3 mm for fractionation and then suction filtered using a filter paper of about 0.8 μm . Many laboratories used glass fiber filters and polycarbonate filters. These laboratories used stereomicroscopes to isolate particles from the sieves or filter paper. However, the analysis results for numbers of particles smaller than 1 mm were less than the design value (about 40-80% of the design value). This was seen across all laboratories, and the variation in the reported values between these laboratories was also great.
- This may reflect the difficulty in visually finding small particles that are mixed in with non-plastic material. Also, as glass petri dishes were used in many cases when isolating the particles, they may have caused difficulty in isolation transparent particles.
- For improvement, it is advisable to work with a microscope as much as possible, using not only the backlight but also the incident light when confirming the existence of particles.
- It is necessary to pay special attention when isolating fibrous particles as they can be mistaken for other materials (natural fibers, etc.).
- At the same time, it is also important to build capacity among analysts to improve the accuracy of the picking process. Therefore, recovery tests and dual identification procedures are recommended.
- Although it is convenient to use sieves before particle isolation, special care should be taken to avoid losing particles that have the longest lengths greater than the sieve openings, which may nonetheless pass through the sieve (see Section 3.4, Fig. 3-3).
- When separating with a sieve, it is desirable to re-collect the sample passed through the finest sieve on filter paper.
- In the ILC, the research institute that conducted re-collection reported a value closer to the design value for fine particles smaller than 1 mm.

3.4 Counting and size measuring



Measurement of microplastics

Measurement using photos of plastic particles and image processing software. The longest length is measured from the captured image and the number of particles are aggregated by size.



Multi-staged sieve with various mesh openings

The photo shows a multi-staged sieve with 4 mm, 1 mm, 0.3 mm and 0.1 mm openings. Plastic particles are poured from the top, and the number of particles remaining in each sieve is aggregated as the number of particles by size.

Keynotes

- Microplastic abundance at the ocean surface is most commonly reported in the number of particles by size.
- There are two common methods for counting the number of particles by size; (1) directly measuring the longest diameter (maximum Feret's diameter) of separated particles individually, and, (2) counting the number of particles remaining in the sample after fractionating by size using sieves of various mesh opening sizes.

Outcomes of the pilot projects

- Many laboratories measured the longest length using image processing software or calipers by method (1) and summed up the number of particles by size. Some laboratories fractionated with sieves of different mesh openings as in method (2), counted the number of particles remaining in each sieve and reported them as the number of particles by size.
- For particles sampled during CMSM2018, the number of plastic particles that were measured for their longest length and particles that were sieve fractionated were compared, with the hypothesis that plastic particles of up to 7 mm, which is around the diagonal length of a 5 mm square mesh opening, would pass through a 5 mm sieve. It was found that the number of particles smaller than 5 mm obtained by the latter method (using sieves) was about 1.25 times larger than by the former. The above findings indicate that in sieve fractionation, the number of particles smaller than 5 mm counted using sieves would be overestimated because particles with the shortest length smaller than the diagonal length of the mesh may pass through the sieve, even if their longest length exceeds 5 mm.

Recommendations

- In terms of harmonization, measuring the longest length of each particle using image processing software is recommended.
- When estimating the number of particles and/or weight of particles by size using only sieves, it is necessary to keep in mind that it would be difficult to compare the results with those of particles measured directly for the longest length.
- We also recommend providing classification of plastic particles by morphological traits such as beads, fragments foams, pellets and fibers, noticing the difficulty of distinguishing between natural and synthetic fibers.

Explanatory Notes

- Feret's diameter is illustrated in Fig. 3-3. The plastic particle size is determined as Feret's diameter, which is generally defined as the distance between the two parallel planes restricting the object perpendicular to that direction (Pabst et al., 2017). The shortest Feret's diameter is called "minimum Feret's diameter" and the longest is called "maximum Feret's diameter".
- Size fractionation by sieving is effective from the viewpoint of efficiency. However, in the case of using a 5 mm lattice sieve mesh, particles up to 7.0 mm, which is the diagonal length of the openings, or fibrous particles having a shortest length may pass through the sieve (Fig. 3-4).
- For one sample collected during CMSM2018, the number of particles by size was compared. The results showed that the number of particles smaller than 7 mm that could pass through the diagonal line of a sieve with a 5 mm lattice was 1,974. When maximum diameters were measured for the same sample, the number of particles obtained smaller than 5 mm was 1,574. When using a 5 mm mesh sieve, the result is overestimated by about 20%, as particles with the longest length of more than 5 mm could also pass through the sieve.
- These findings suggest the possibility that sieve fractionation may lead to the overestimation of particles < 5 mm in size.
- When only sieving is used, care should be taken to note the fact that the obtained results cannot be compared to fractionation results obtained by measuring the longest lengths. Consequently, it would be desirable to measure the longest lengths and aggregate the number of particles by size.
- Recently, image capturing devices and software/applications capable of image processing can be obtained inexpensively, and particle size measurement by image processing is relatively easy. Therefore, it would be desirable to measure particle sizes using these devices and software.
- When measuring the longest lengths with image processing software, it would be preferable to record the shortest lengths and projected area simultaneously.
- Depending on the purpose of the study, the shape and color of the plastic particles may need to be recorded. Guidelines which recommend recording these include EC, (2013) etc..
- The shape and color of plastic particles are valuable information for identifying sources. More information is presented in Rochman et al., 2019. Also, as the color of plastics is considered to be

related to uptake by organisms (e.g., Des forges et al., 2015, Steer et al., 2017.), it is important to acquire these data for future study.

- In many studies, classification by shape, commonly used shape categories include fragments, beads, foam, pellets and fibers.
- If the projected area of each particle is measured after classifying the particles by shape, it may be possible to convert the projected area to weight with a conversion formula using volume, weight and plastic density. Accumulations of data both on the projected area of particles and their weight would provide a formula to convert the projected area of a particle to its weight or vice versa. The average weight per particle may be also estimated for each sample by dividing the total weight of particles sampled by their number.

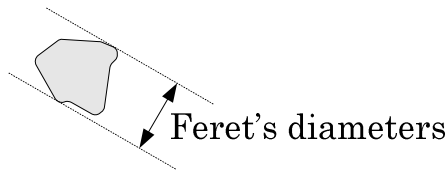

Fig. 3-3. Feret's diameter

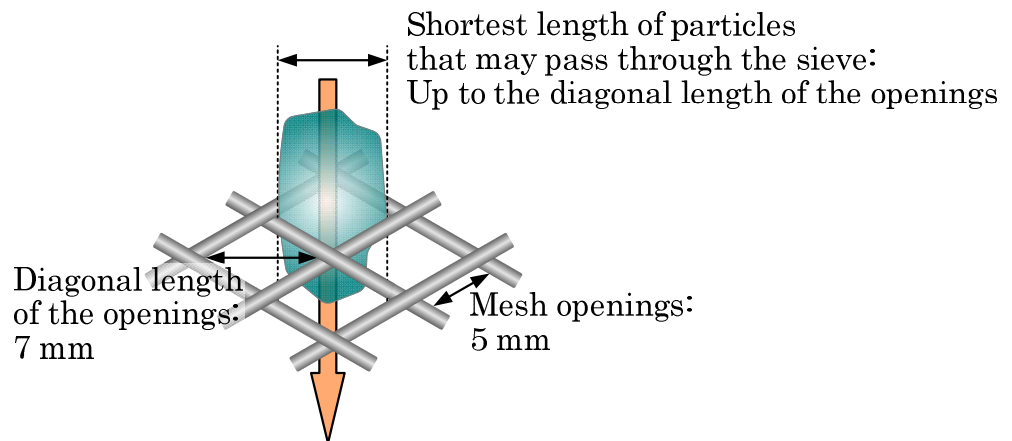
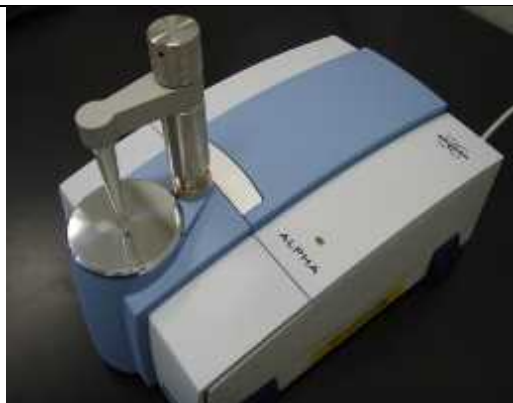

Fig. 3-4. Relationship of the mesh openings of a sieve to the particle sizes that may pass through.

3.5 Material identification



Bruker FTIR



Composition analysis by FTIR

Keynotes

- Spectral optical instruments such as IR/Raman spectroscopy are used most commonly to separate microplastics from non-plastic materials and identify polymers.

Outcomes of the pilot projects

- Many laboratories who participated in the ILC used Fourier Transform Infrared Spectroscopy (FTIR, including ATR-FTIR) for material identification, while others used Raman spectroscopy.

Recommendations

- From the viewpoint of harmonization and accuracy, it is essential to confirm the material of plastic particles using the spectral optical instruments to ensure accuracy of separation by hand-picking.
- Even when using spectroscopy, knowledge of chemistry is recommended and appropriate training is required when conducting separation because it may be difficult to determine whether particles are made of plastic or not.
- In addition, when confirming materials by visual inspection without using spectral optical instruments such as FTIR, having an analyst who is skilled at separating plastic particles is recommended.

Explanatory Notes

- Visually identifying microplastics from non-plastic material is generally difficult at the hand-picking stage, especially with particles <1 mm. Confirming that particles picked out are plastics and correcting the counting or measurement results is desirable.
- Even if it is difficult to analyze characteristics of all microplastic by spectroscopy, confirming the characteristics of some of the particles by spectroscopy is recommended.
- The EC guideline (EC, 2013) recommends spectroscopic analysis for a subsample of 10% of the identified particles to verify visual identification, and this method has been applied in several reports (e.g., Lusher et al., 2018). The European Union's Marine Strategy Framework Directive

(MSFD) also recommends that a proportion (5-10%) of all samples be routinely checked to confirm the accuracy of visual examination (Gago et al., 2016).

- At the International Experts Meeting held to examine these guidelines, it was pointed out that a best-case scenario would be testing all particles for chemical composition with FTIR or similar devices. In cases where time and resources do not allow this, a representative subsample would be a part of the total sample that reflects the composition of particles, both in shape and color. For example, if there are both fragments and fibers in a ratio of 1:5, at least one fragment to every 5 fibers should be assessed to a value which exceeds 20% of the overall total.
- In the ILC, laboratories that identified the material only by visual confirmation reported larger quantities than the design value of the standard samples due to errors in mistaking natural particles for plastic ones.
- Particularly for small particles with the longest length of less than 1 mm, it would be easy to misidentify plastics and non-plastic material when conducting visual inspection only, so even when studying plastic particles larger than 1 mm and less than 5 mm, if there are many small particles of 1 to 2 mm, use of a spectral optical instrument for composition analysis is recommended.
- The accuracy of hand-picking relying solely on visual observation with a stereoscopic microscope was particularly low, although there were only a few laboratories that did not use spectral optical instruments to isolate microplastics. Meanwhile, the laboratories that applied other methods such as pushing the particles with a needle, etc., in addition to visual observation, reported values close to the design value.
- Understanding the composition of plastics using spectral optical instruments such as FTIR, ATR-FTIR, Raman spectroscopy, or infrared cameras, is useful not only for separating the particles from other materials but also for obtaining useful information in regard to the sources of the plastics.
- It is necessary to note that biofilms adhering to particle surfaces may make it difficult to identify materials or analyze composition using spectral optical instruments and that a certain amount of experience is required to be able to determine if the obtained spectra reflect the characteristics of plastics or not. If uncertain about particle analysis, it would be desirable to check the results with an experienced analyst.
- Advantages and disadvantages of recent microplastic characterization methods, including identification of polymer types, are shown in Table 3-4.
- In recent years, equipment such as automated ATR-FTIR that can perform counting, shape measurement and material identification simultaneously has started coming into use.

Table 3-4.(1) Advantages and disadvantages of microplastic characterization methods, including identification of polymer types (reproduced from Shim et al. (2017)).

Identification method	Advantages	Disadvantages
Microscopy	Simple	No chemical information for confirming composition
	Low cost	High possibility of false positives
	Color and morphological information	High possibility of missing small and transparent particles
Microscopy + spectroscopy (sub-set)	Polymer composition of a sub-set of the sample	Possibility of false positives
		Possibility of missing small and transparent particles
		Sub-set may not be representative Potential bias in sub-set selection
Microscopy + FTIR spectroscopy	No false positives – confirmation of all plastic-like particles	Manual selection of particles means some plastic may be missed
	Reduction in false negatives	Expensive instrument
	Non-destructive	Laborious and time-consuming for identification of all particles
	20 µm particle detection limit	Requires expertise in spectral interpretation
		Contact analysis (ATR)
		Need to transfer particles from filter paper to metal plate Removal of organic material a prerequisite
Microscopy + Raman spectroscopy	No false positives – confirmation of all plastic-like particles	Manual selection of particles means some plastic may be missed
	Reduction in false negatives	Expensive instrument
	1 µm particle detection limit	Laborious and time-consuming for identification of all particles
	Non-destructive analysis	Requires expertise in spectral interpretation
	Non-contact analysis	Interference by pigments
		Risk of laser damage to particles Removal of organic material a prerequisite Exact focusing required

Table 3-4 (2). Advantages and disadvantages of microplastic characterization methods, including identification of polymer types (reproduced from Shim et al. (2017)).

Identification method	Advantages	Disadvantages
Semi-automated spectroscopy (mapping based)	No manual particle selection error	No visual image data on single particles
	High automation potential	Production of a large volume of data
	In principle no false negatives	Long post-processing time
		Still requires expertise in spectral interpretation
		Efficient removal of interfering particles a pre-requisite
		Still lacks validation for smaller particles
		Expensive instrument
Semi-automated spectroscopy (image analysis directed point analysis)	High automation potential	Production of a large volume of data
	Fewer false negatives	Long post-processing time
	Potential for faster sample throughput	Still requires expertise in spectral interpretation
	Size and morphology of single particles	Efficient removal of interfering particles a pre-requisite
		Still lacks validation for smaller particles
	Expensive instrument	
Thermal analysis	Simultaneous analysis for polymer type and additive chemicals (Pyro-GC/MS)	Destructive analysis
	Mass-based information	No quantity or size-based information
		Limited polymer type identification (DSC)
		Complex data (Pyro-GC/MS)

3.6 Weight measurement



Sample drying

Generally, drying prior to weighing is performed at room temperature.



Weight measurement

Weighing of microplastics in a glass vial.

Keynotes

- Weight measurement is carried out because it is important to understand the mass balance. It is also difficult to estimate the actual abundance of microplastics from the number of the particles only. This is because even if the same amount of microplastics exists at the ocean surface by weight, the number of particles may differ depending on fragmentation processes. Recommendations and guidelines on weight measurement have been issued by the EC and NOAA (EC, 2013, Masura et al., 2015.).

Outcomes of the pilot projects

- All laboratories participating in the ILC provided weight measurements of the standard samples irrespective of whether or not they normally carried out weight measurements.
- In measuring the weight of the standard samples, for particles 1 mm or larger and less than 5 mm, there were no significant differences between the results reported from each laboratory and the design value. On the other hand, for smaller particles less than 1 mm, results from the laboratories that had conducted digestion of organic matter before measuring the weight were closer to the design value than those from other laboratories.
- In response to a questionnaire distributed after the survey in the ILC, many of the laboratories reporting relatively low accuracy in weight values suggested that in all probability insufficient drying affected the weight measurement.

Recommendations

- It is important to wash each sample with distilled water and dry it thoroughly before measuring its weight. Attention should be paid to humidity and the laboratory atmosphere.
- Also, to obtain more accurate results, digesting organic matter in the pretreatment process is recommended (see Section 3.2).
- Reporting weight for both particles smaller than 1 mm and particles larger than 1 mm separately is recommended.

Explanatory Notes

- Weight measurement (dry weight) of microplastics may be carried out based on the purpose of the survey, such as for detailed analysis of plastic particle distribution in sea areas.
- In the preliminary questionnaire, only four laboratories out of the 12 laboratories participating in the ILC reported that they measured the weight (or measured the weight and number) in their routine measurements. In the ILC, all laboratories were requested to measure weight.
- Out of the 12 laboratories, drying prior to weight measurement was done at room temperature at 11 laboratories, and at 60°C at one laboratory.
- Results of testing showed no significant differences among values reported from each laboratory regarding the weight of microplastics larger than 1 mm and less than 5 mm contained in the standard samples.
- Meanwhile, results of weight measurement of microplastics smaller than 1 mm in the ILC closer to the design value were obtained by laboratories that conducted digestion of organic substances compared to those that did not. This is thought to have been the result of improvement in the precision of isolation of small particles and size fractionation through the removal of non-plastic material by digestion of organic substances.
- Also, with respect to microplastics larger than 1 mm and smaller than 5 mm, the digestion of organic substances is considered an effective process for achieving better accuracy in weight measurement because samples obtained from actual sea areas may contain particles with sessile animals or biofilms adhering to the surface.
- Furthermore, laboratories with large errors in weight measurement results in the ILC reported insufficient drying as the major factor influencing weight measurement.
- From the viewpoint of harmonizing monitoring methods, performing adequate digestion of organic substances and drying the particles thoroughly are thought desirable for achieving accurate weight measurement.
- However, measuring the weight of particles smaller than 1 mm is prone to error at the separation process, even with adequate digestion of organic substances and thorough drying (see Section 3.3). Hence, reporting is not considered essential as the difficulty is expected in obtaining comparable results based on the analytical methods presented in these Guidelines.

3.7 Accuracy control during analysis

Keynotes

- In laboratory analysis, countermeasures, for preventing airborne contamination such as with fibrous matter and contamination from washing water in the fractionation and filtration processes, are important, such as conducting blank tests in the laboratory or using filtered water to wash the equipment (EC, 2013, Masura et al, 2015). In recent articles, specific steps have been proposed to reduce and quantify this kind of contamination for accurate output (see Table 3-5 reproduced from Lusher, 2018).
- Hermsen et al. (2018) reviewed many cases of quality control for surveys and experiments on microplastics. This serves as a very useful reference and referring to it before surveys is recommended.
- Spiked recovery tests using relevant reference particles (similar properties as sample particles but still clearly distinguishable, e.g. by distinct colors) are also effective for assessing extraction efficiency or loss in the digestion protocols or density separation (GESAMP, 2019).
- Also, the experience and ability of the analysts are thought to be very important in the accuracy control.

Outcomes of the pilot projects

- In preliminary questionnaires for participating laboratories, some laboratories responded that they used specific facilities such as clean benches and others excluded fibrous materials as potential contaminants. In addition, there were several laboratories using specified water filtered through 0.7 to 1µm filters for washing in the fractionation process.

Recommendations

- It is desirable to include information in the report on measures taken to prevent contamination that may affect the accuracy of the analysis. It is also desirable to record the humidity and temperature of the laboratory atmosphere.

Explanatory Notes

- In the discussions at the International Experts' Meetings, reporting of quality assurance/quality control data was recognized as important.
- Examples of quality assurance/quality control data include blank tests in the analytical process, recovery rates, repeatability, etc.
- In the preliminary questionnaire given to the laboratories in ILC, eight laboratories reported using a clean bench, etc., and one laboratory was excluding fibrous particles as a measure.
- Examples of contamination risks and the measures against them are shown in Table 3-6.
- When ILC was implemented, there were at least two laboratories using water filtered using 0.7-1 µm filters for washing the mesh prior to fractionation.

- What has been particularly prominently mentioned in past research has been airborne contamination in which cloth-derived synthetic fibers adhere to analytical instruments and samples via the air in the laboratory (Nuelle et al., 2014, Wesch et al., 2017). Careful attention is necessary when analyzing fibrous microplastics.

Table 3-5. Examples of steps to prevent microplastic contamination. (modified from Lusher et al. (2018)).

1	All sample containers should be prewashed with filtered distilled water before use.
2	Samples should be kept covered as much as possible using aluminum foil or glass lids.
3	All equipment used in the processing and analysis stages should be rinsed and checked under a microscope for any microplastics adhering to them. The vacuum filtering apparatus should be rinsed with filtered water between each sample.
4	All reagents should be vacuum filtered through Whatman GF/D filter papers or other sterile filter papers immediately prior to use.
5	Sample processing should be performed in a sterile cabinet.
6	Several procedural blanks should be performed as negative control samples through the sample processing and analytical stages in order to test for laboratory contamination.

Table 3-6. Examples of contamination risks and preventive measures.

Contamination risks	Preventive measures
Contamination with plastic particles adhering to analytical instruments/apparatuses	Pour purified water into the apparatus used for analysis beforehand and conduct the same analytical process as for sample treatment to confirm the presence or absence of microplastics.
Contamination with fibrous microplastics during operations	Wear clothing that is not plastic-derived and remove any loose fibers from clothing with a lint roller before sampling and analysis. For example, wear clothing of a unique and visible color so that the fiber can be distinguished even if it contaminates the sample.
Contamination with plastics from air	Use of clean benches and clean rooms. Implementation of blank tests in the laboratory.

4. Reporting

- Observed abundances of ocean surface microplastics are commonly reported in terms of density, or weight of particles per unit area ($/m^2$, $/km^2$) or unit volume of water ($/m^3$).
- Densities of microplastics per unit area need to be reported together with the sampling depth to allow comparisons to be made between those per unit area and those per unit volume of water.
- Reports on the distribution of ocean surface microplastics should include not only their quantities or weight per unit area or per volume of water, but also their particle sizes and materials, and metadata at the time of their sampling.
- For example, collected quantities of microplastics plus the shapes of individual particles make it theoretically possible to convert them to weight. If data on wind speeds and wave heights are available for estimating the intensity of vertical mixing of water, abundances of underwater microplastics can also be estimated by sampling at the surface layer (Kukulka et al., 2012., Kooi et al., 2016.).
- It is also necessary to record and report how each sample was stored and analyzed. Upon completion of these analyses, maintaining visual representations (pictures, etc.) obtained at the time of measurement would be desirable.
- As for the scale of samplings required to obtain the typical density of microplastics in a certain sea area, Dr. Cózar (personal communication) suggested 120 tows (one tow usually ranges between 500 and 2000 m^2) for 174,000 m^2 , while Goldstein et al. (2012) recommended 250 tows for 165,000 m^2 . The total area surveyed may be more important than the number of samplings in studying the typical density of microplastics in certain sea areas, and further consideration is required.
- In the Guidelines, data to be reported to ensure harmonization of ocean surface microplastic monitoring are summarized in Table 4-1 to Table 4-3. In these tables, the items were selected for the harmonization of monitoring methods. Among these items, the “fundamental” items are the minimum requirements to identify the abundance of microplastics, the sampling time and location, and microplastic density which can be displayed in any of the following four units: number of particles/ m^3 or km^2 , weight/ m^3 or km^2 . The “essential” items are the minimum requirements to make the survey results comparable.
- The data-input form summarizing these items were distributed.

Table 4-1(1) List of data to be reported when sampling floating microplastics.

Items	Data necessary to ensure comparability		Category
Sampling date and location	Sample name/ ID		
	Time difference from GMT.		E
	Sampling date and time	Start of trawl	FA, E
		End of trawl	E
	Season		E
	Sampling Location (Name)		E
	GPS Log	Input style (select sexagesimal (base 60) notation or decimal notation to input coordinates.)	FA, E
		Coordinates at the start of trawl	FA, E
Coordinates at the end of trawl		E	
Sampling equipment	Classification of net frame	Type of net frame	E
		Model number and manufacturer	E
	Net aperture	Shape of net aperture	FC, E
		Width of net aperture (m)	FC, E
		Height of net aperture (m)	E
		Area of net aperture (m ²)	E
	Length of net		E
	Mesh	Openings (Size and select one side length or diagonal length)	E
Model number and manufacturer		E	
Tow Parameters	Name of vessel		
	Tow distance	Distance (m)	FC, E
		Calculation method (Using flow meter, speed relative to water or GPS Log.)	E
		Calculation formulas	
	Trawl sweep area	Sweep area (m ²)	FC, E
		Calculation formulas	
	Filtered water volume	Water volume (m ³)	FC, E
		Calculation formulas	
	Tow duration	(minutes)	FC, E
	Vessel speed	(Speed relative to water, knots)	FC, E
	Tow position	(Side or stern of a vessel)	E
Distance from vessel	(m)	E	

• The meanings of the letters listed in the category column are as follows:

FA, FB and FC represent “fundamental” items. The “fundamental” items are the minimum requirement to identify the abundance of microplastics, the sampling time and location, and microplastic density, which can be displayed in any of the following four units: number of particles/m³ or km², weight/m³ or km².

FA: All the “FA” are necessary for displaying the density.

FB: At least one (1) item in “FB” is necessary for displaying the density. The symbol * (asterisk) with FB indicates some additional items among “FC” would be necessary to calculate microplastic density.

- The letter “E” represents “essential” items which are the minimum requirements to make the survey results comparable.
- The items with no letter in the " Category " column are those that may be obtained optionally, depending on the specific purpose of individual surveys or instrument availability.
- Reporting all data obtained is recommended, including metadata sets.

Table 4-1(2) List of data to be reported when sampling floating microplastics.

Items	Data necessary to ensure comparability	Category
Tow Parameters	Net immersion depth (m)	FC, E
	Percentage of net immersion depth to size of net frame (%)	
	Whether or not there was any change in the immersion depth during tow.	E
	Tow direction	E
	Blank tests	Whether or not blank tests were conducted Results (particles/test)
Metadata (weather, sea conditions, water quality)	Wind direction and speed (degrees, m/s)	E
	Significant wave height (measure using an onboard wave meter.) ※When a wave-height meter is not available on the sampling vessel, wave height data from nearby tide stations or websites can be recorded instead.	
	Beaufort scale (Visual observation)	E
	Vessel movements (Heave, pitch, roll)	E
	Sea surface temperature (degrees Celsius)	E
	Sea surface salinity (-)	E
	Water current direction and speed (degrees, knot)	
	Other types of water quality data (Chlorophyll, fluorescence, etc.)	
State of floating debris on the sea surface. (Large floating debris, drifting algae, etc.)	E	

- The meanings of the letters listed in the category column are as follows:
 FA, FB and FC represent “fundamental” items. The “fundamental” items are the minimum requirement to identify the abundance of microplastics, the sampling time and location, and microplastic density, which can be displayed in any of the following four units: number of particles/m³ or km², weight/m³ or km².
 FA: All the “FA” are necessary for displaying the density.
 FB: At least one (1) item in “FB” is necessary for displaying the density. The symbol * (asterisk) with FB indicates some additional items among “FC” would be necessary to calculate microplastic density.
- The letter “E” represents “essential” items which are the minimum requirements to make the survey results comparable.
- The items with no letter in the " Category " column are those that may be obtained optionally, depending on the specific purpose of individual surveys or instrument availability.
- Reporting all data obtained is recommended, including metadata sets.

Table 4-2 List of data to be reported for laboratory analysis of microplastics.

Items	Data necessary to ensure comparability	Category	
Density separation	Whether or not density separation was conducted	E	
	Type of solution used for density separation (NaCl, ZnCl ₂ , etc.)	E	
	Concentration of solution used for density separation (%)	E	
	Processing time (minutes)		
Biological digestion and chemical treatment	Whether or not biological digestion or chemical treatment was conducted	E	
	Methods used for digesting organic matter (acid treatment, alkaline treatment, enzyme treatment, oxidation treatment, etc.)	E	
	Temperature during processing (degrees Celsius)	E	
	Reaction time (minutes)	E	
Sample splitting	Whether or not sample splitting was conducted	E	
	Method or equipment of splitting	E	
	Estimated relative error range caused by splitting process		
Isolation of microplastics	Whether or not pretreatment before particle isolation was conducted	E	
	Type of pretreatment (fractionation by size including non-plastic materials by sieve, etc.)	E	
	Whether or not picking was conducted under stereomicroscope.	E	
Counting and measuring sizes of particles	Method of size fractionation (whether the maximum diameter was measured or sieves were used)	E	
	Diameters of the measured particles (maximum and minimum Feret's diameters, area)	E	
Identification of microplastics	Whether or not composition analysis was conducted	E	
	Method of composition analysis (FTIR, Raman spectroscopy, etc.)	E	
	Percentage of the particles subjected to composition analysis (%)	E	
Weight measurement	Temperature of sample drying (degrees Celsius)	E	
	Humidity of sample drying (%)		
	Processing time of sample drying (minutes)	E	
	Methods of weight measurement	E	
QA/QC	Blank tests	Whether or not blank tests were conducted	E
		Results (particles/test)	
	Spiked recovery tests	Whether or not spiked recovery tests were conducted	E
		Results (%)	

• The meanings of the letters listed in the category column are as follows:

FA, FB and FC represent “fundamental” items. The “fundamental” items are the minimum requirement to identify the abundance of microplastics, the sampling time and location, and microplastic density, which can be displayed in any of the following four units: number of particles/m³ or km², weight/m³ or km².

FA: All the “FA” are necessary for displaying the density.

FB: At least one (1) item in “FB” is necessary for displaying the density. The symbol * (asterisk) with FB indicates some additional items among “FC” would be necessary to calculate microplastic density.

• The letter “E” represents “essential” items which are the minimum requirements to make the survey results comparable.

• The items with no letter in the " Category " column are those that may be obtained optionally, depending on the specific purpose of individual surveys or instrument availability.

• Reporting all data obtained is recommended, including metadata sets.

Table 4-3 List of data to be reported for results of microplastic survey.

Items	Data necessary to ensure comparability	Category	
Weight and number of plastic particles	Maximum Feret's diameter $1.0\text{mm} \leq d < 5.0\text{mm}$	Number of particles (particles)	FB*
		Particle number density (per filtered water volume, particles/m ³)	FB, E
		Particle number density (per trawl swept area, particles/km ²)	FB, E
		Total weight (g)	FB*
		Particle weight density (per filtered water volume, g/m ³)	FB, E
		Particle weight density (per trawl swept area, g/km ²)	FB, E
	Maximum Feret's diameter $d < 1.0\text{mm}$	Number of particles (particles)	FB*
		Particle number density (per filtered water volume, particles/m ³)	FB
		Particle number density (per trawl swept area, particles/km ²)	FB
		Total weight (g)	FB*
		Particle weight density (per filtered water volume, g/m ³)	FB
		Particle weight density (per trawl swept area, g/km ²)	FB
	Total (maximum Feret's diameter $d < 5.0\text{mm}$)	Number of particles (particles)	FB*
		Particle density (per filtered water volume, particles/m ³)	FB
		Particle density (per trawl swept area, particles/km ²)	FB
		Total weight (g)	FB*
		Particle weight density (per filtered water volume, g/m ³)	FB
		Particle weight density (per trawl swept area, g/km ²)	FB
Properties of the plastic particles	$1.0\text{mm} \leq d < 5.0\text{mm}$	Shapes of microplastics. (Category, percentage)	E
		Material of microplastics. (Category, percentage)	
		Colors of microplastics. (Category, percentage)	
	$d < 1.0\text{mm}$	Shapes of microplastics. (Category, percentage)	
		Material of microplastics. (Category, percentage)	
		Colors of microplastics. (Category, percentage)	

• The meanings of the letters listed in the category column are as follows:

FA, FB and FC represent “fundamental” items. The “fundamental” items are the minimum requirement to identify the abundance of microplastics, the sampling time and location, and microplastic density, which can be displayed in any of the following four units: number of particles/m³ or km², weight/m³ or km².

FA: All the “FA” are necessary for displaying the density.

FB: At least one (1) item in “FB” is necessary for displaying the density. The symbol * (asterisk) with FB indicates some additional items among “FC” would be necessary to calculate microplastic density.

• The letter “E” represents “essential” items which are the minimum requirements to make the survey results comparable.

• The items with no letter in the " Category " column are those that may be obtained optionally, depending on the specific purpose of individual surveys or instrument availability.

• Reporting all data obtained is recommended, including metadata sets.

5. Conclusions

- The Guidelines summarize recommendations for harmonization of ocean surface microplastic survey methods to facilitate the generation of comparative results with the assumption that various sampling and processing methods will be still used in the future. Those recommendations are also useful for surveys conducted in freshwater systems.
- Many studies are expected to be carried out involving microplastic monitoring at the ocean surface for various purposes. Application of the harmonized methods proposed in the Guidelines will facilitate result generation in a comparable manner, enabling researchers to analyze, consolidate and integrate all the available data.
- Data gaps are expected to be filled in the future by surveys in various countries and areas where surveys have yet to be conducted, and at the same time, comparison of the results obtained from surveys conducted worldwide to date and accumulation of data measured using harmonized methods are expected to facilitate understanding of the global status of microplastic pollution.
- Current data on the abundances of microplastics in the ocean suggests the existence of some unknown mechanism for their removal and identifying the distributions of ocean surface microplastic densities is expected to elucidate the process of their generation through to their disappearance via migration.
- It is important to tackle the following technological challenges for improving the efficiency and accuracy of identifying the status of oceanic microplastic pollution.
 - Automation of microplastic analysis (size measurements and composition analyses) and ocean sampling for efficiency and speed, including faster speedier analysis. The turnaround time from sampling to data acquisition could be shortened, allowing prompt confirmation of the comparability and adequacy of the samplings, so that complementary samplings can be conducted as required for improving overall accuracy.
 - Development of techniques to improve the accuracy of measuring tiny microplastics smaller than 1 mm.
- As one of the further actions, a database for creating a two-dimensional map (2-D maps) of microplastics at the ocean surface will be constructed in order to fill the above mentioned gaps and to elucidate unknown processes.
- The purposes of the 2-D maps are follows:
 - Facilitate understanding of the actual state of global microplastic pollution.
 - Contribute to solving issues such as described in the SDGs Target 14.1.
 - Provide basic data that can be used for efficient environmental monitoring, for use in computer simulations and for further harmonization of monitoring methods.
 - The final goal of administrative interest might be for their use as basic data in biological risk assessments.

References

- Aliani, S., Lusher, A., Galgani, F., Herzke, D., Nikiforov, V., Primpke, S., ... & van Bavel, B. (2023). Reproducible pipelines and readiness levels in plastic monitoring. *Nature Reviews Earth & Environment*, 1-2. <https://www.nature.com/articles/s43017-023-00405-0>
- A L. Lusher, Gema Hernandez-Milian., (2018), Microplastic Extraction from Marine Vertebrate Digestive Tracts, Regurgitates and Scats: A Protocol for Researchers from All Experience Levels, bio-protocol, Vol 8, Iss 22, Nov 20, 2018 DOI:10.21769/BioProtoc.3086.
- Botterell, Z.L., Beaumont, N., Dorrington, T., Steinke, M., Thompson, R.C. & Lindeque, P.K. (2018). Bioavailability and effects of microplastics on marine zooplankton: A review. *Environmental Pollution*, 245, 98-110.
- Claessens, M., van Cauwedberghe, L., Vandegheuchte, M.B. & Janssen C.R. (2013). New techniques for the detection of microplastics in sediments and field collected organisms. *Marine Pollution Bulletin*, 70, 227-233.
- Dehaut, A., Cassone, A.L., Frere, L., Hermabessiere, L., Himber, C., Rinnert, E., Riviere G., Lambert C., Soudant, P., Huvet, A., Duflos G. & Paul-Pont, I. (2016). Microplastics in seafood: Benchmark protocol for their extraction and characterization. *Environmental Pollution*, 215, 223-233.
- Desforges, J.P.W., Galbraith, M. & Ross, P.S. (2015). Ingestion of microplastics by zooplankton in the Northeast Pacific Ocean. *Archives of Environmental Contamination and Toxicology*, 69(3), 320-330.
- Di Mauro, R., Kupchik, M.J. & Benfield, M.C. (2017). Abundant plankton-sized microplastic particles in shelf waters of the northern Gulf of Mexico. *Environmental Pollution*, 230, 798-809.
- Eriksen, M., Liboiron, M., Kiessling, T., Charron, L., Alling, A., Lebreton, L., Richard, H., Roth, B., Ory, N.C., Hidalgo-Ruz, V., Meerhoff, E., Box, C., Cummins, A. & Thiel, M. (2018). Microplastic sampling with the AVANI trawl compared to two Neuston trawls in the Bay of Bengal and South Pacific. *Environmental Pollution*, 232, 430-439.
- Fossi, M.C., Marsili, L., Bainsi, M., Giannetti, M., Coppola, D., Guarranti, C., Caliani, I., Minutoli, R., Lauriano, G., Finoia, M.G., Rubegni, F., Panigada, S., Bérubé, M., Ramirez, J.U. & Panti, C., (2016). Fin whales and microplastics: The Mediterranean Sea and the sea of Cortez scenarios. *Environmental Pollution*, 209, 68-78.
- Gago, J., Galgani, F., Maes, T. & Thompson, R.C. (2016). Microplastics in seawater: recommendations from the marine strategy framework directive implementation process. *Frontiers in Marine Science*, 3, 219.
- Galgani, F., Hanke, G., Werner, S., Oosterbaan, L., Nilsson, P., Fleet, D., Kinsey, S., Thompson, R.C., van Franeker, J., Vlachogianni, T., Scoullou, M., Veiga, J.M., Palatinus, A., Matiddi, M., Maes, T., Korpinen, S., Budziak, A., Leslie, H., Gago, J., Liebezeit, G., 2013. Guidance on Monitoring of Marine Litter in European Seas. EUR Scientific and Technical Research Series. Publications Office of the European Union, Luxembourg, 123 pp.
- GESAMP (2015). Sources, fate and effects of microplastics in the marine environment: a global

assessment. (P. J. Kershaw, ed.). (IMO/FAO/UNESCO-IOC/UNIDO/WMO/IAEA/UN/UNEP/UNDP Joint Group of Experts on the Scientific Aspects of Marine Environmental Protection). Rep. Stud. GESAMP No. 90, 96 pp.

- GESAMP (2016). Sources, fate and effects of microplastics in the marine environment: part two of a global assessment (P. J. Kershaw and C. M. Rochman, eds). (IMO/FAO/UNESCO-IOC/UNIDO/WMO/IAEA/UN/UNEP/UNDP Joint Group of Experts on the Scientific Aspects of Marine Environmental Protection). Rep. Stud. GESAMP No. 93, 220 pp.
- GESAMP (2019). Guidelines for the monitoring and assessment of plastic litter in the ocean (P.J. Kershaw, A. Turra and F. Galgani, eds). (IMO/FAO/UNESCO-IOC/UNIDO/WMO/IAEA/UN/UNEP/UNDP/ISA Joint Group of Experts on the Scientific Aspects of Marine Environmental Protection). Rep. Stud. GESAMP No. 99.
- Goldstein, M.C., Titmus, A. J. & Ford, M. (2013). Scales of spatial heterogeneity of plastic marine debris in the northeast Pacific Ocean. *PloS one*, 8(11), e80020.
- Hermsen, E., Mintenig, S. M., Besseling, E., & Koelmans, A. A. (2018). Quality criteria for the analysis of microplastic in biota samples: a critical review. *Environmental science & technology*, 52(18), 10230-10240.
- Hidalgo-Ruz, V., Gutow, L., Thompson, R.C. & Thiel M. (2012). Microplastics in the marine environment: A review of the methods used for identification and quantification. *Environmental Science & Technology*, 46, 3060-3075.
- Hurley, R. R., Lusher, A. L., Olsen, M., & Nizzetto, L. (2018). Validation of a method for extracting microplastics from complex, Organic-Rich, Environmental Matrices. *Environmental science & technology*, 52(13), 7409-7417.
- Imhof, H.K., Schmid, J., Niessner, R., Ivleva, N.P. & Laforsch, C. (2012). A novel, highly efficient method for the separation and quantification of plastic particles in sediments of aquatic environments. *Limnology and oceanography: methods*, 10(7), 524-537.
- Isobe, A. (2016). Percentage of microbeads in pelagic microplastics within Japanese coastal waters. *Marine pollution bulletin*, 110(1), 432-437.
- Isobe, A., Buenaventura N.T., Chastain, S., Chavanich, S., Cózar, A., Delorenzo, M., Hagmann, P., Hinata, H., Kozlovskii, N., Lusher, A.L., Martí, E., Michida, Y., Mu, J., Ohno, M., Potter G., Ross, P.S., Sagawa, N., Shim, W.J., Song, Y.K., Takada, H., Tokai, T., Tori, T., Uchida, K., Vasilenko, K., Viyakarn, V. & Zhang, W. (2019) An interlaboratory comparison exercise for the determination of microplastics in standard sample bottles. *Marine Pollution Bulletin*, 146, 831-837
- Isobe, A., Uchida, K., Tokai, T. & Iwasaki, S. (2015). East Asian seas: a hot spot of pelagic microplastics. *Marine Pollution Bulletin*, 101(2), 618-623.
- Kang, J.H., Kwon, O.Y., Lee, K.W., Song, Y.K. & Shim, W.J. (2015). Marine neustonic microplastics around the southeastern coast of Korea. *Marine Pollution Bulletin*, 96(1-2), 304-312.
- Kooi, M., Reisser, J., Slat, B., Ferrari, F.F., Schmid, M.S., Cunsolo, S., Roberto, B., Kimberly, N., Lys-Anne, S., Theo, E.W., Linders., Schoeneich-Argent, R.I. & Albert A.K. (2016). The effect of particle properties on the depth profile of buoyant plastics in the ocean. *Scientific Reports*, 6, 33882.

- Kukulka, T., Proskurowski, G., Morét - Ferguson, S., Meyer, D.W. & Law, K.L. (2012). The effect of wind mixing on the vertical distribution of buoyant plastic debris. *Geophysical Research Letters*, 39, L07601.
- Lima, A.R.A., Barletta, M. & Costa, M.F. (2015). Seasonal distribution and interactions between plankton and microplastics in a tropical estuary. *Estuarine, Coastal and Shelf Science*, 165, 213-225.
- Lippiatt, S., Opfer, S. & Arthur, C. 2013. Marine Debris Monitoring and Assessment. NOAA Technical Memorandum NOS-OR&R-46.
- Löder, M.G.J., Imhof, H.K., Ladehoff, M., Loschel, L.A., Lorenz, C., Mintenig, S., Piehl, S., Primpke, S., Schrank, I., Laforsch C. & Gerdt, G. (2017). Enzymatic purification of microplastics in environmental samples. *Environmental Science and Technology*, 51(24), 14283-14292.
- Lusher, A.L., Hurley, R., Vogelsang, C., Nizzetto, L. & Olsen, M. (2017). Mapping microplastics in sludge. NIVA technical report.
- Lusher, A. L., & Primpke, S. (2023). Finding the Balance between Research and Monitoring: When Are Methods Good Enough to Understand Plastic Pollution? *Environmental Science & Technology*, 57 (15) , 6033 – 6039. <https://pubs.acs.org/doi/full/10.1021/acs.est.2c06018>
- María B. Alfonso, Kayoko Takashima, Sayaka Yamaguchi, Mie Tanaka, Atsuhiko Isobe., (2021), Microplastics on plankton samples: Multiple digestion techniques assessment based on weight, size, and FTIR spectroscopy analyses. *Marine Pollution Bulletin*, 173, Part A.
- Masura, J., Baker, J., Foster, G. & Arthur, C. (2015). Laboratory methods for the analysis of microplastics in the marine environment: recommendations for quantifying synthetic particles in waters and sediments. NOAA Technical Memorandum. NOS-OR&R-48.
- Miller, M.E., Kroon, F.J. & Motti, C.A. (2017). Recovering microplastics from marine samples: A review of current practices. *Marine Pollution Bulletin*, 123, 6-18.
- Nuelle, M.T., Dekiff, J.H., Remy, D. & Fries, E. (2014). A new analytical approach for monitoring microplastics in marine sediments. *Environmental Pollution*, 184, 161-169.
- Ogi, H., Bab, N., Ishihara, S. & Shibata, Y., (1999). Sampling of Plastic Pellets by Two Types of Neuston Net and Plastic Pollution in the Sea. *Bulletin of the Faculty of the Fisheries Hokkaido University*, 50(2), 77-91.
- Pabst, W., Gregorová, E., (2007). Characterization of particles and particle systems. ICT Prague 1-122.
- Reisser, J.W., Slat, B., Noble, K.D., Plessis, K.D., Epp, M., Proietti, M.C., Sonnevile J.D., Becker, T. & Pattiaratchi, C. (2015). The vertical distribution of buoyant plastics at sea: an observational study in the North Atlantic Gyre *Biogeosciences Discussions*. 11, 16207-16226.
- Rochman, C.M., Regan, F. & Thompson, R.C. (2017). On the harmonization of methods for measuring the occurrence, fate and effects of microplastics. *Analytical Methods*, 9(9), 1324-1325.
- Saito, H. (2018). Plankton net. Guidelines of Ocean Observations Vol. 6 Plankton and Benthos, The

Oceanographic Society of Japan, pp 601EN1-9.

- Shim, W.J., Hong, S.H. & Eo, S. (2017). Identification methods in microplastic analysis: A review. *Analytical Methods*, 9, 1384- 1391.
- Steer, M., Cole, M., Thompson, R.C. & Lindeque, P.K. (2017). Microplastic ingestion in fish larvae in the western English Channel. *Environmental Pollution*, 226, 250-259.
- Suaria, G., Avio, C.G., Mineo, A., Lattin, G.L., Magaldi, M.G., Belmonte, G., Moore, C.J., Regoli F. & Aliani, S. (2016). The Mediterranean Plastic Soup: synthetic polymers in Mediterranean surface waters. *Scientific Reports*, 6, 37551.
- Syakti, A.D., Hidayati, N.V., Jaya, Y.V., Siregar, S.H., Yude, R., Asia, L., Wong-Wah-Chung, P. & Doumenq, P. (2018). Simultaneous grading of microplastic size sampling in the Small Islands of Bintan water, Indonesia. *Marine Pollution Bulletin*, 137, 593-600.
- Tranter, D.J. & Smith, P.E. (1968). Filtering performance In D.J. Tranter (ed) Monographs on oceanographic methodology 2, Zooplankton sampling”, UNESCO Press, Paris, 27-56.
- UNEP (2016). Marine plastic debris and microplastics – Global lessons and research to inspire action and guide policy change. United Nations Environment Programme, Nairobi.
- Van der Hal, N., Ariel, A. & Angel, D.L. (2017). Exceptionally high abundances of microplastics in the oligotrophic Israeli Mediterranean coastal waters. *Marine Pollution Bulletin*, 116(1-2), 151-155.
- Van Guelpen, L., Markle, D.F. & Duggan, D.J. (1982). An evaluation of accuracy, precision, and speed of several zooplankton subsampling techniques. *ICES Journal of Marine Science*, 40(3), 226-236.
- Wesch, C., Elert, A.M., Wörner, M., Braun, U., Klein, R. & Paulus, M. (2017). Assuring quality in microplastic monitoring: About the value of clean-air devices as essentials for verified data. *Scientific Reports*, 7(1), 5424.
- Zobkov, M. & Esiukova, E. (2017). Microplastics in Baltic bottom sediments: Quantification procedures and first results. *Marine Pollution Bulletin*, 114: 724-732.